

How can architecture improve the standing
of sound in the designed environment?

ANDREW BUDKE
SOUNDSCAPE
FINAL REVIEW

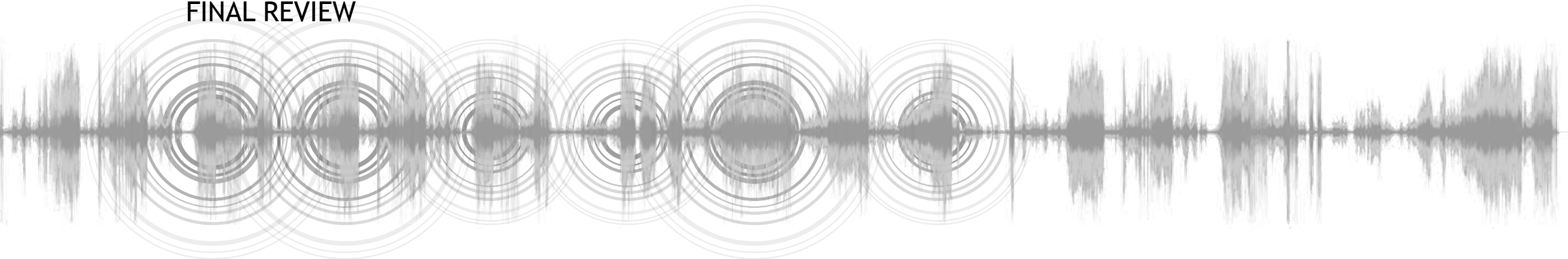

As an interaction with the built environment, the anticipated perception of sound can be used to guide and inform the process of architectural design.

THEORETICAL PREMISE
UNIFYING IDEA

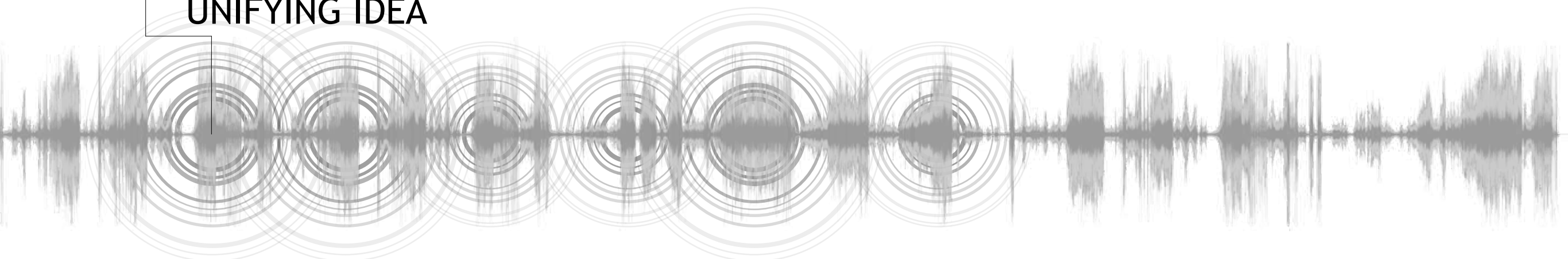

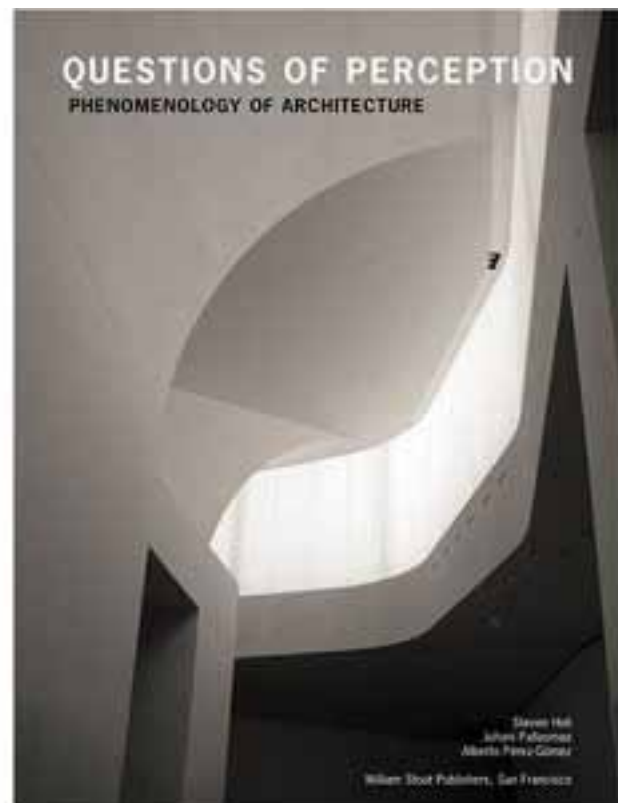

“The echo of steps on a paved street has an emotional charge because the sound bouncing off the surrounding walls puts us in direct interaction with space; the sound measures space and makes its scale comprehensible. We stroke the edges of the space with our ears.”
(pg. 31)

“The timeless task of architecture is to create embodied existential metaphors that concretize and structure man’s being in the world.”
(pg. 37)

Juhani Pallasmaa

Holl, S., Pallasmaa, J., & Pérez, G. A. (2006). *Questions of Perception: Phenomenology of Architecture*. San Francisco, CA: William Stout.

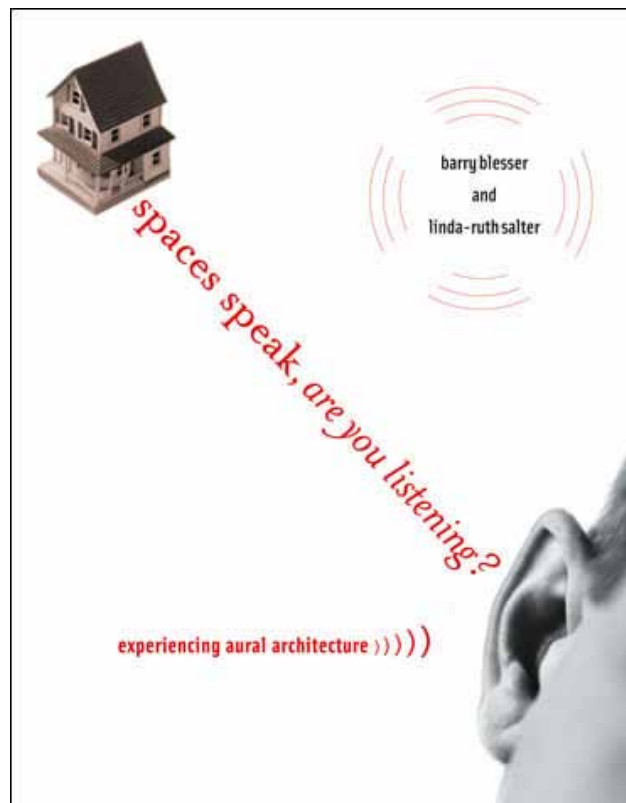

“Architecture, like a giant, hollowed-out sculpture, embeds those who find themselves within it ... But that embedding differs between the aural and visual modalities because human activities produce sound but not light.”
(pg. 16)

“Although both [sound and light] have a frequency spectrum and amplitude intensity, *time* is central to sound but mostly irrelevant for vision.”
(pg. 16)

Barry Blesser

Blesser, B., & Salter, L.-R. (2007). *Spaces speak, are you listening?: Experiencing aural architecture*. Cambridge, Mass: MIT Press.

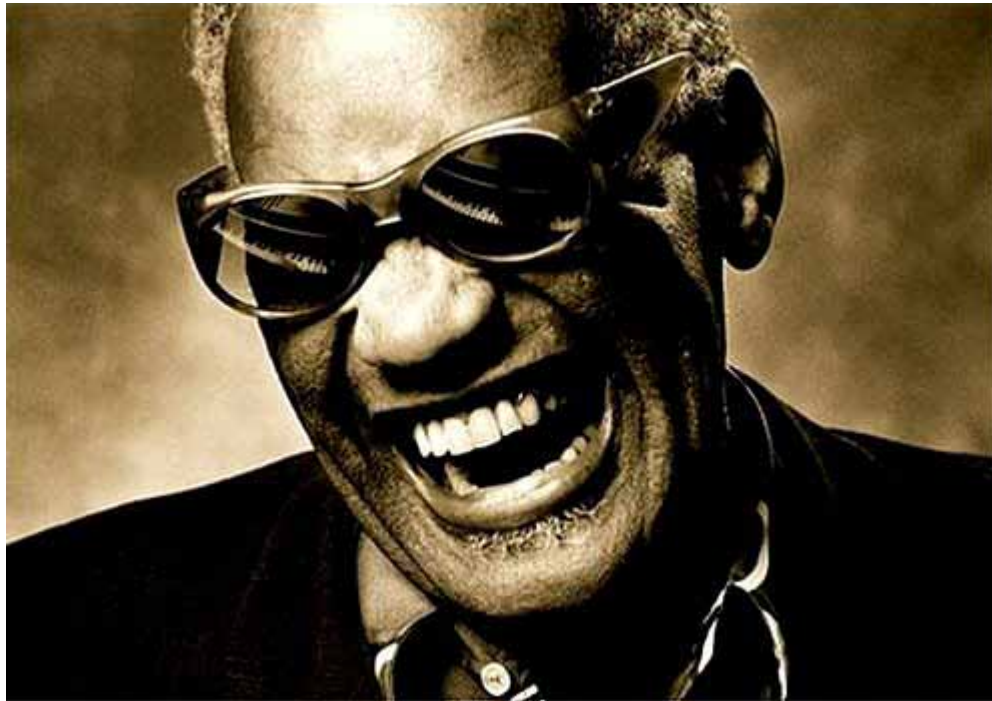

Acoustical Research Laboratory

For the study of auditory spatial perception; that is, the perception of one's surroundings through audition.

- I. Psychoacoustics
- II. Brain Imaging

Used by:
researchers, subjects, administrators, grant
writers, IRB compliance, support staff

T TYPOLOGY

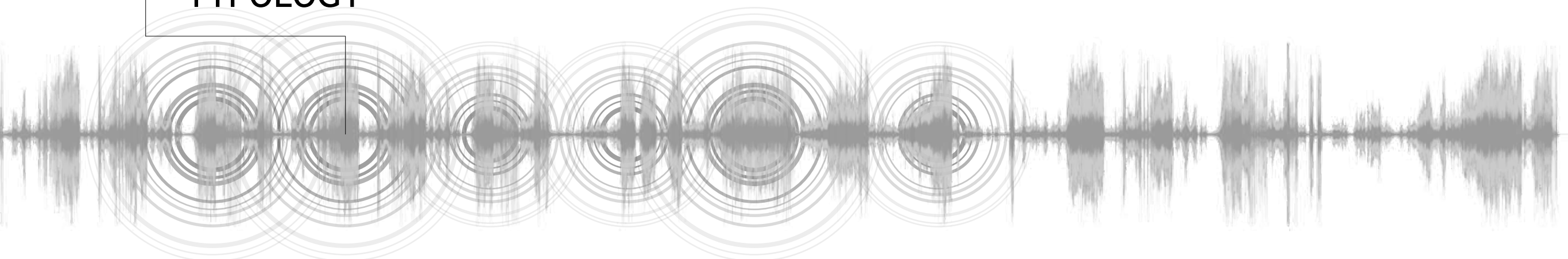

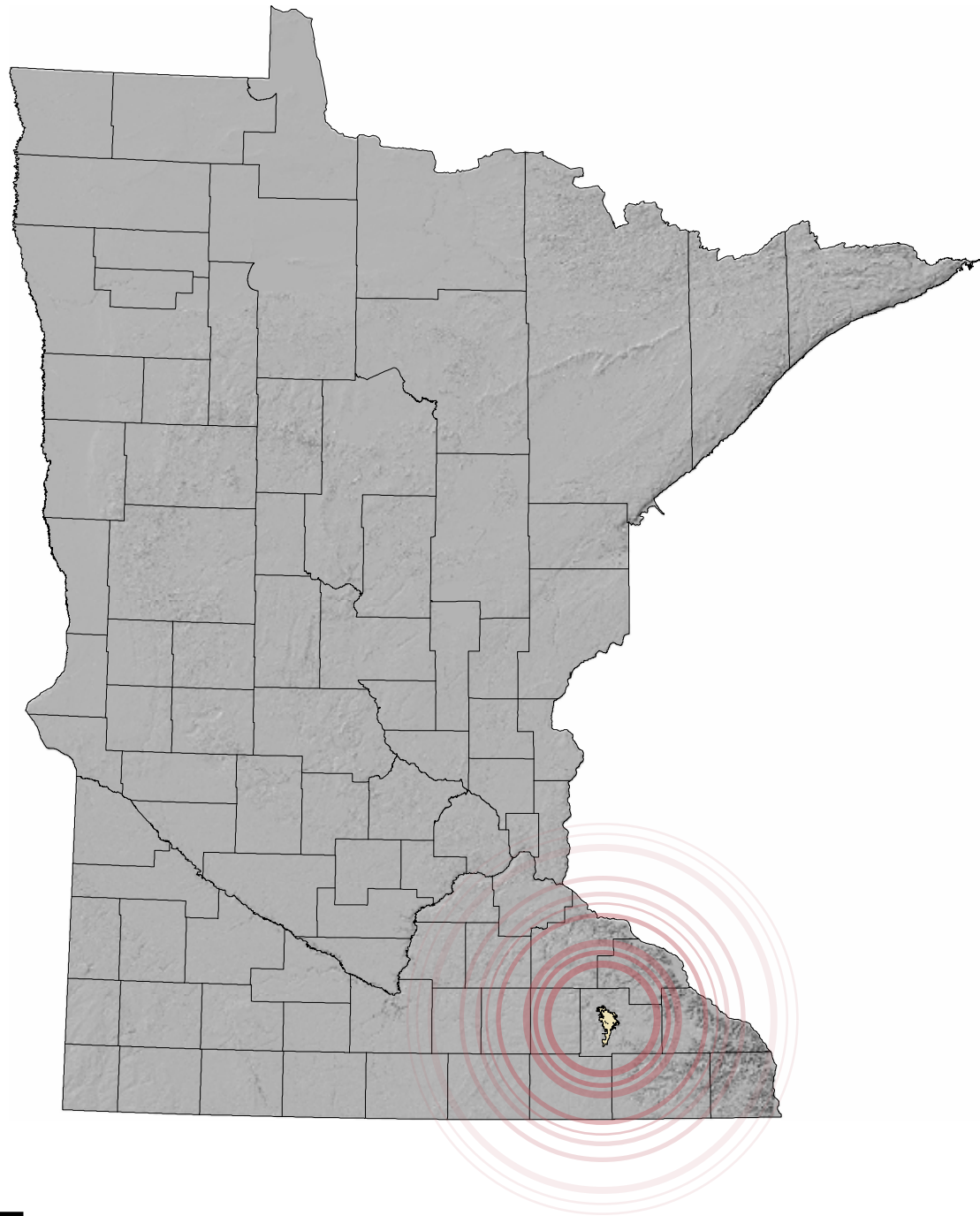

Rochester
Olmsted County
Minnesota

2010 CENSUS:
106,769

MAJOR EMPLOYERS:
Mayo Clinic - 32,000
IBM - 4,200

SITE

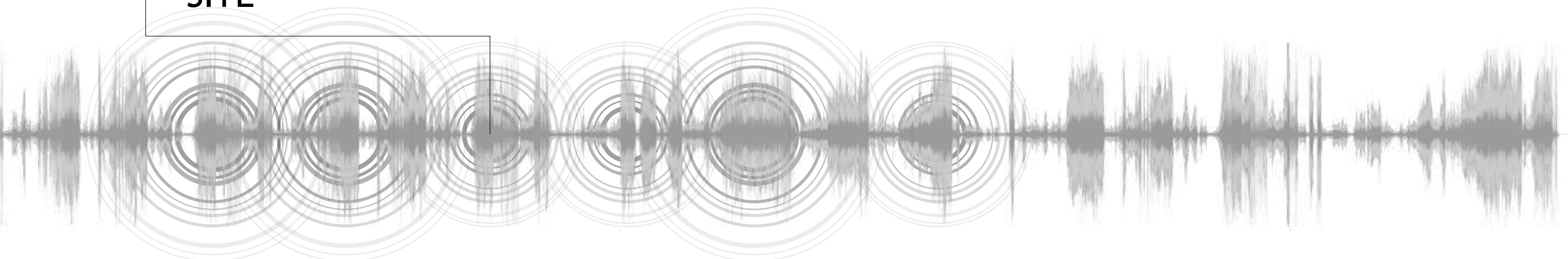

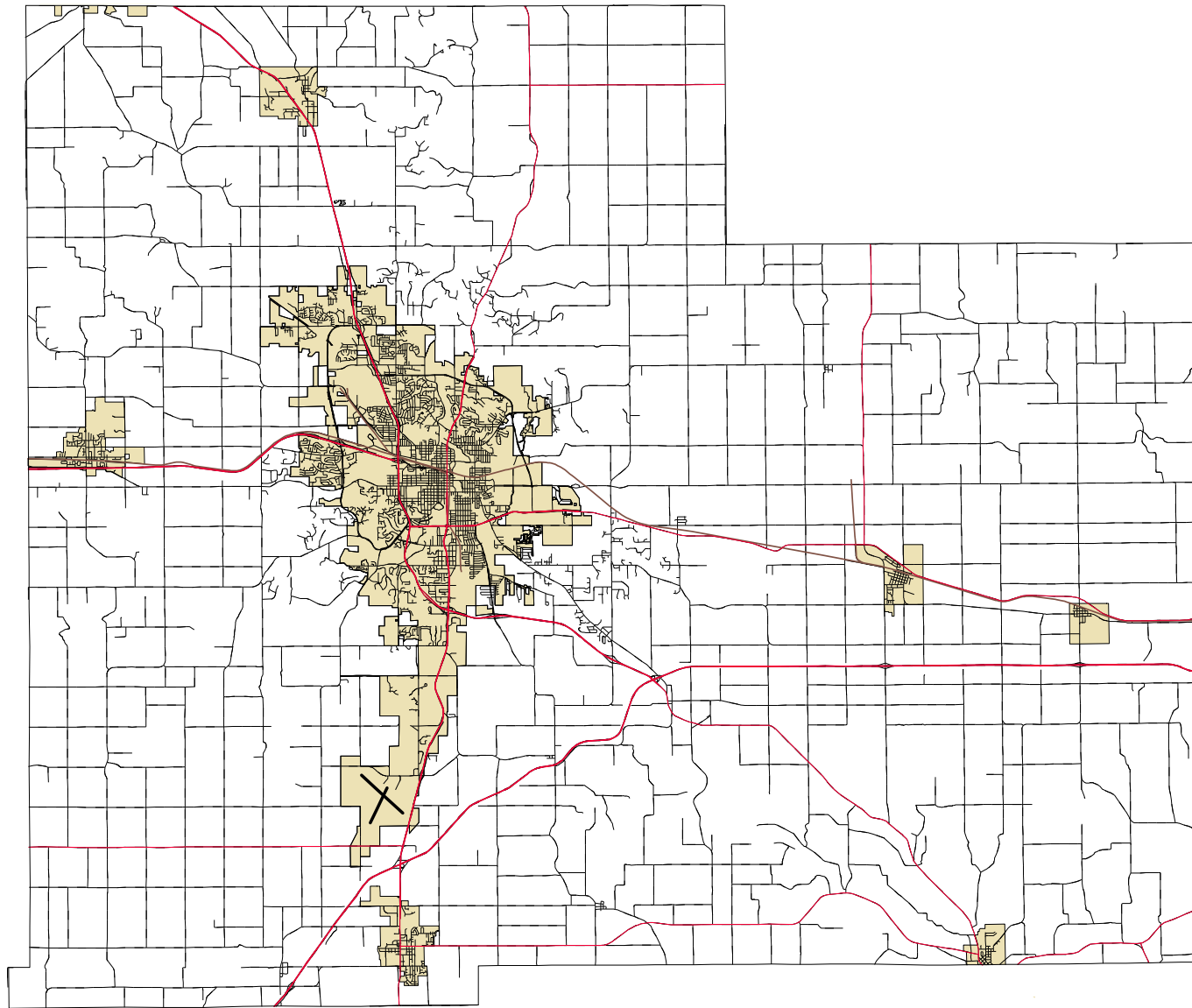

MAJOR INDUSTRIES:
Healthcare
Medical Research
Technology
Agriculture
Industrial Aggregate



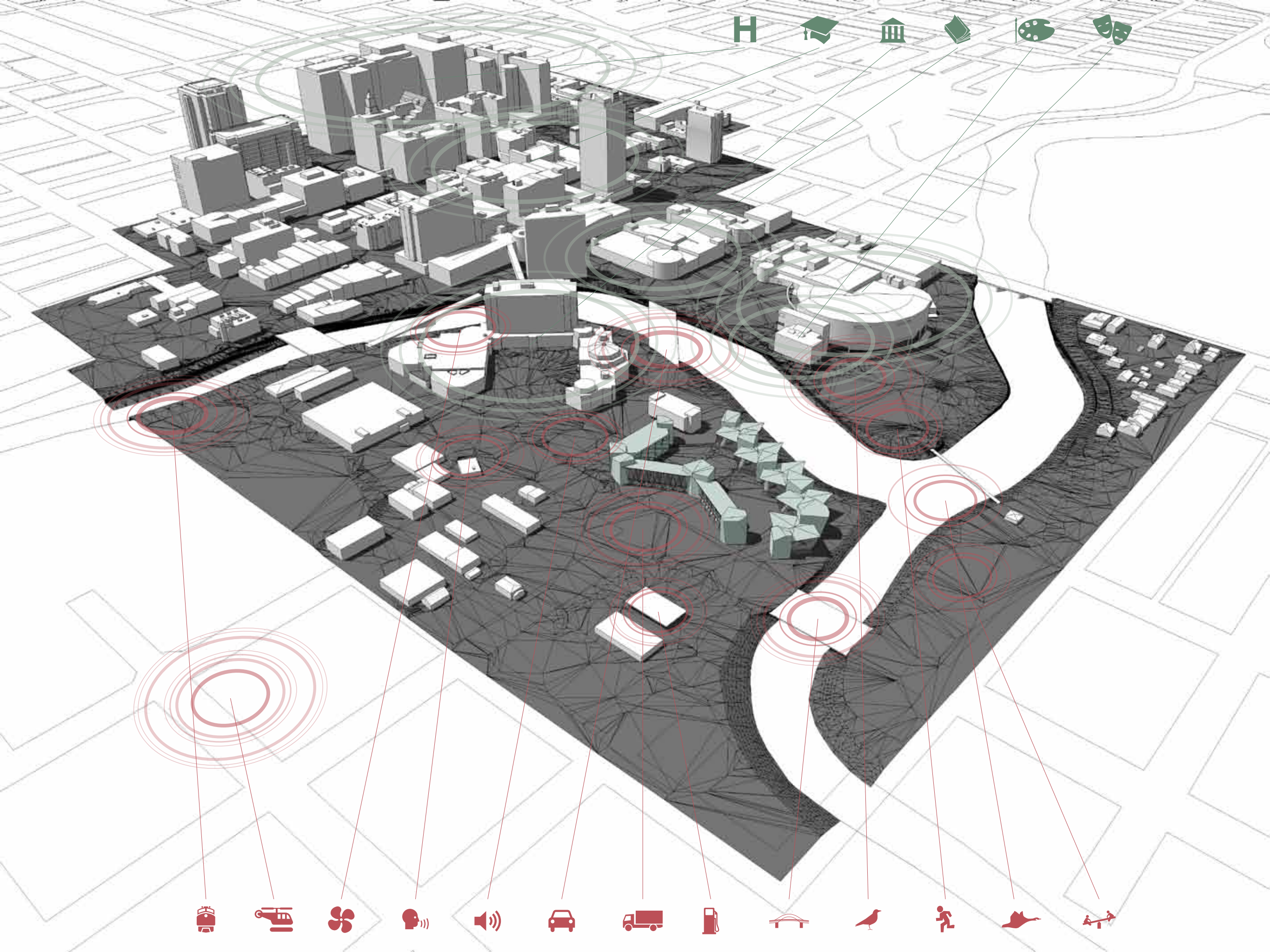

H













RESEARCH WORKSPACES

16 team workspaces

1 library

LABORATORIES

12 headphone booths

4 EEG booths

1 MEG suite

1 fMRI suite

1 synthetic sound field room

1 anechoic chamber

ADMINISTRATION

PROGRAM

A decorative graphic at the bottom of the page consists of a series of overlapping circles of varying sizes and shades of gray, creating a ripple effect. A horizontal line with a small vertical step at the left end is positioned above the circles. Below the circles, there is a dark, stylized waveform or sound visualization that spans the width of the page.



DOREA
University of Minnesota

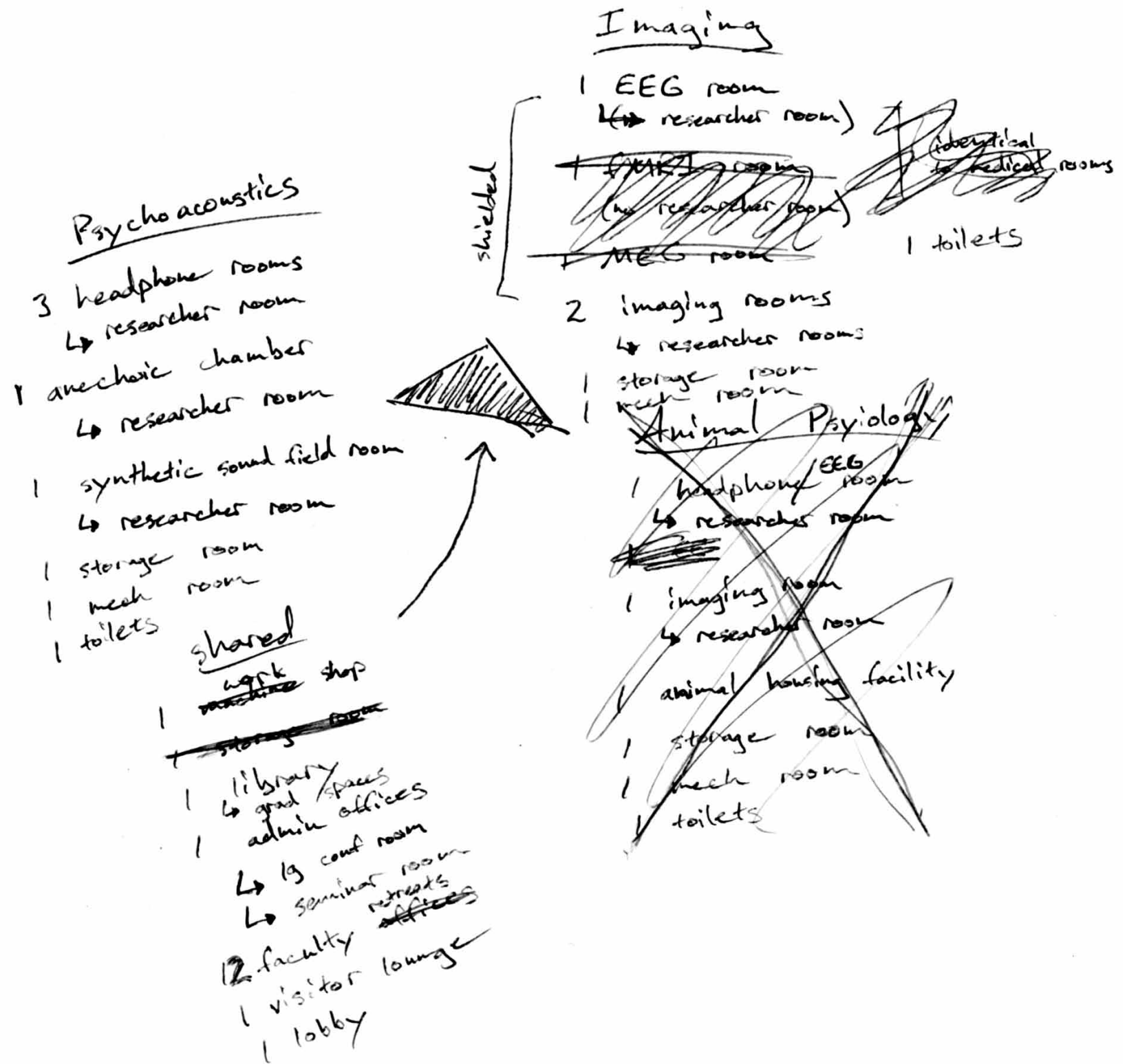

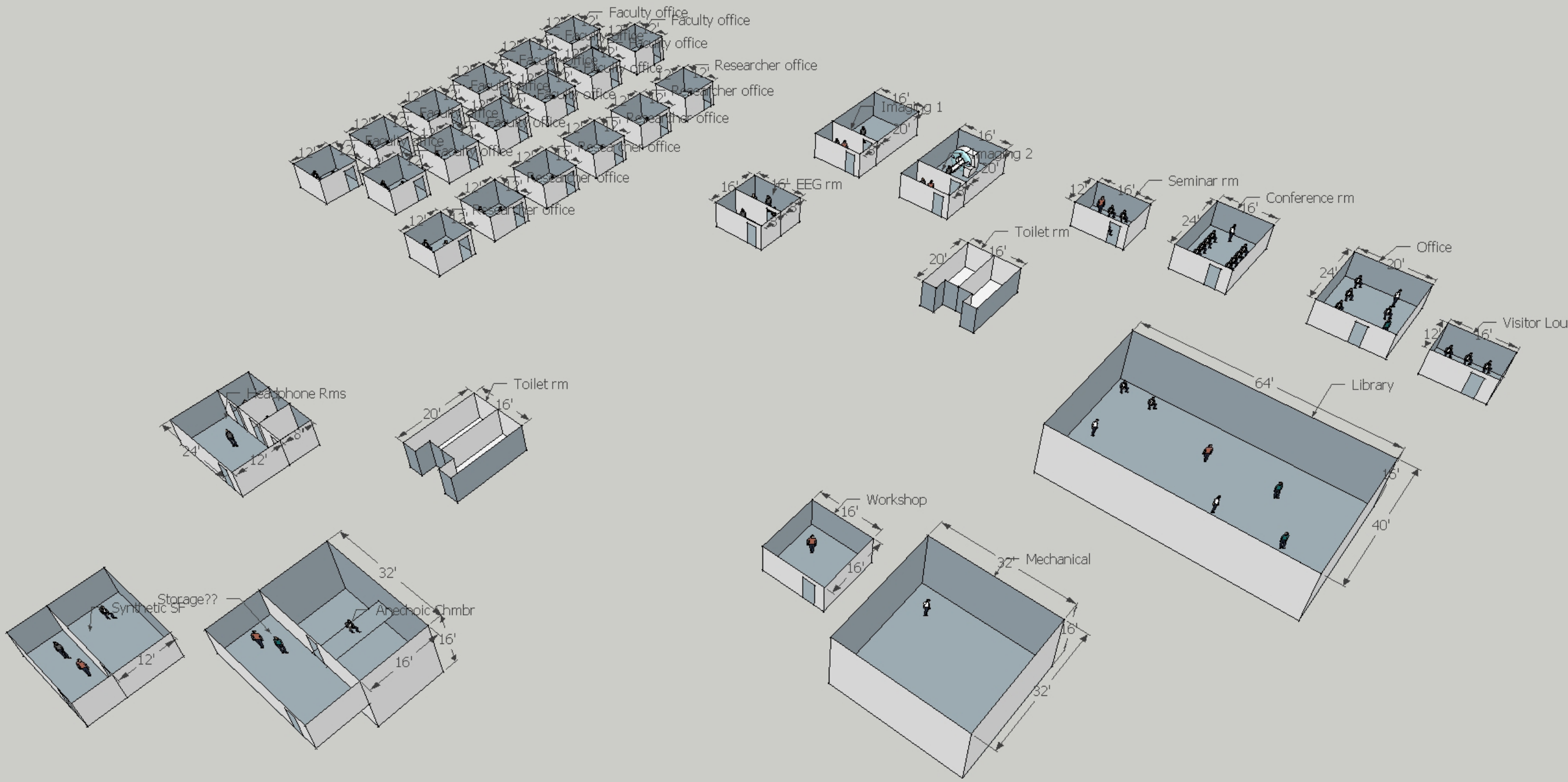

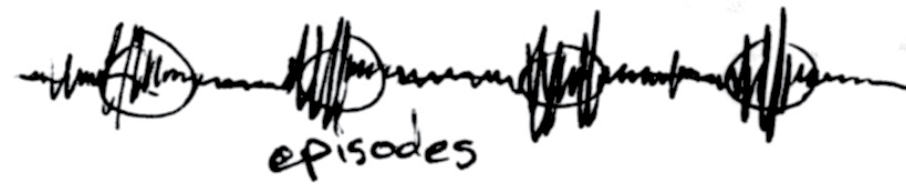
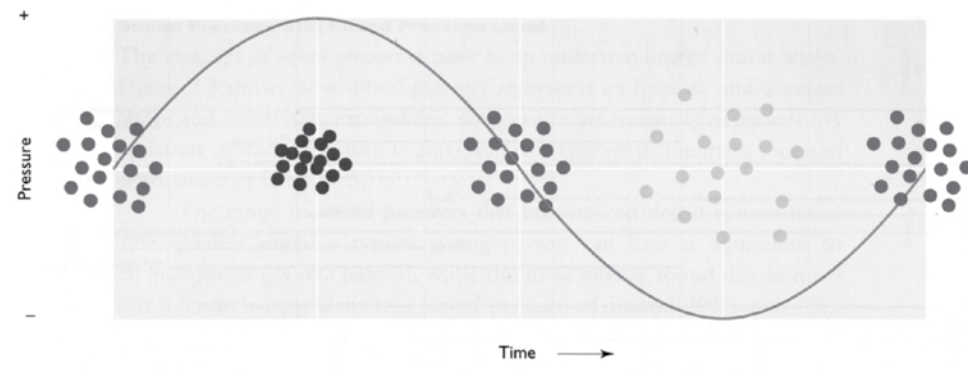



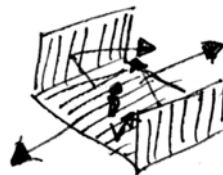
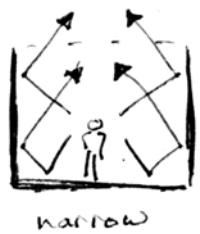
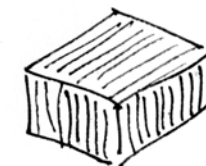
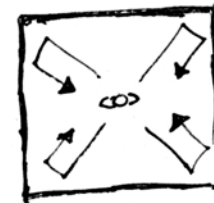
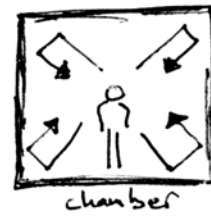
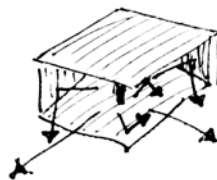
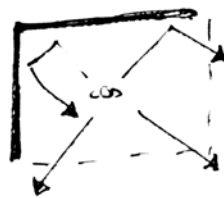
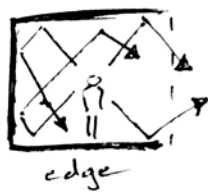
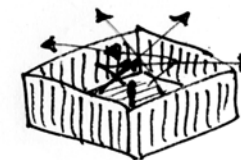
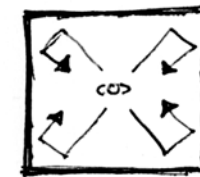
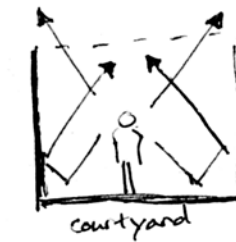
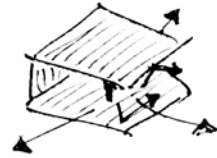
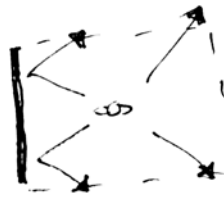
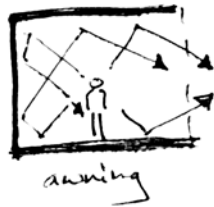
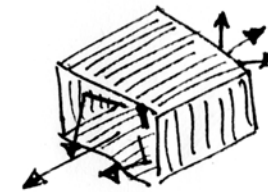
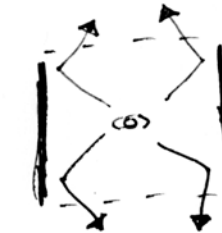
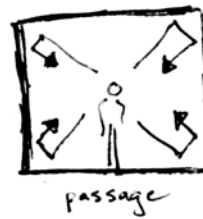
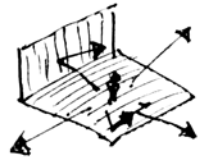
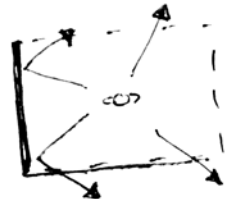
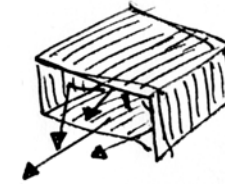
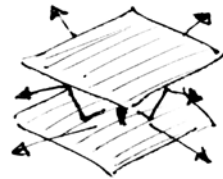
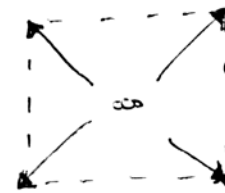
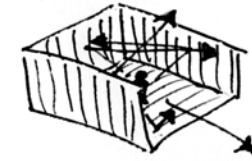
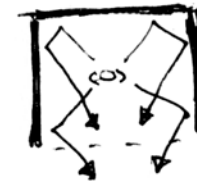
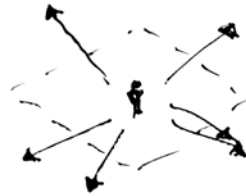
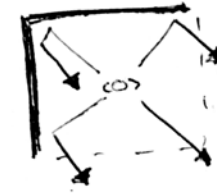
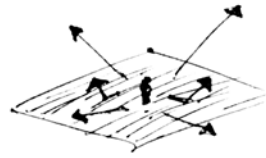
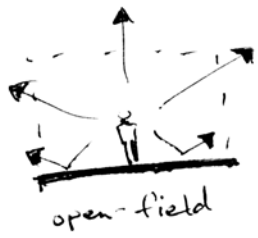

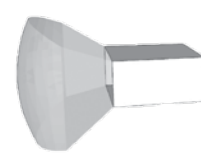
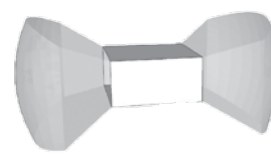
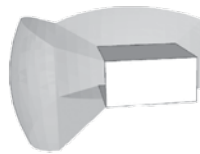
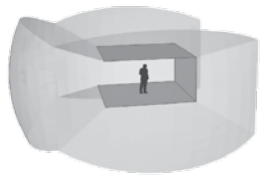
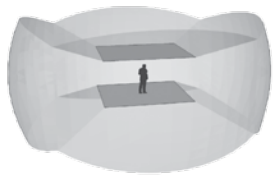
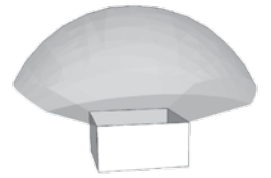
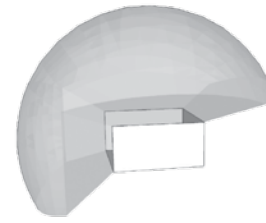
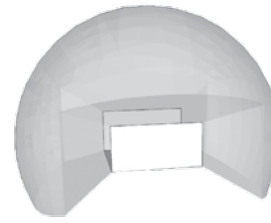
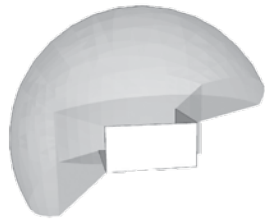
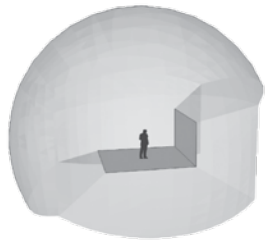
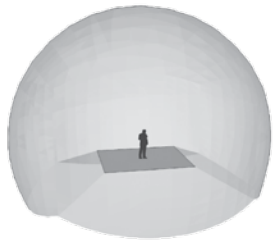

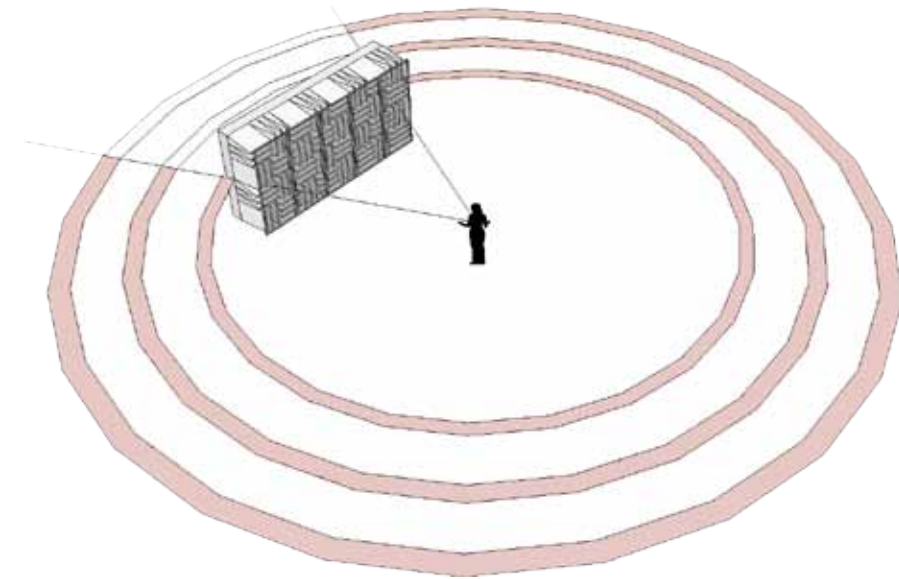
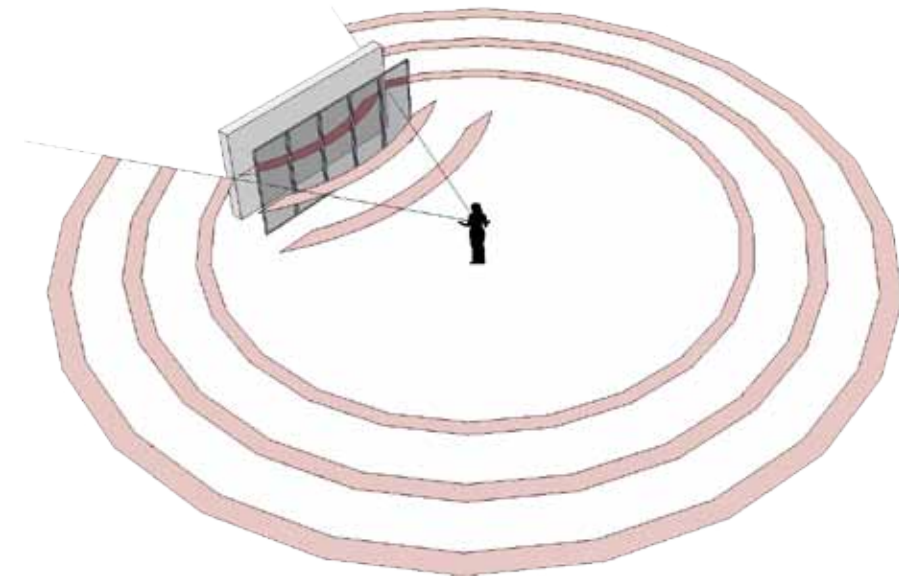
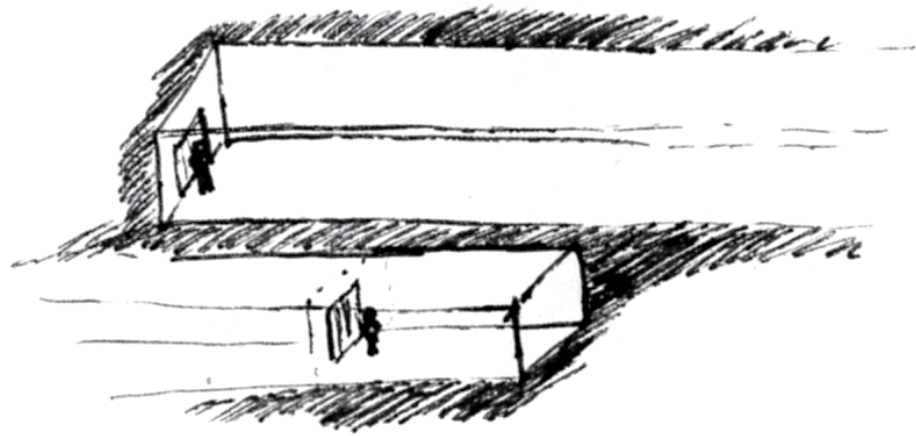

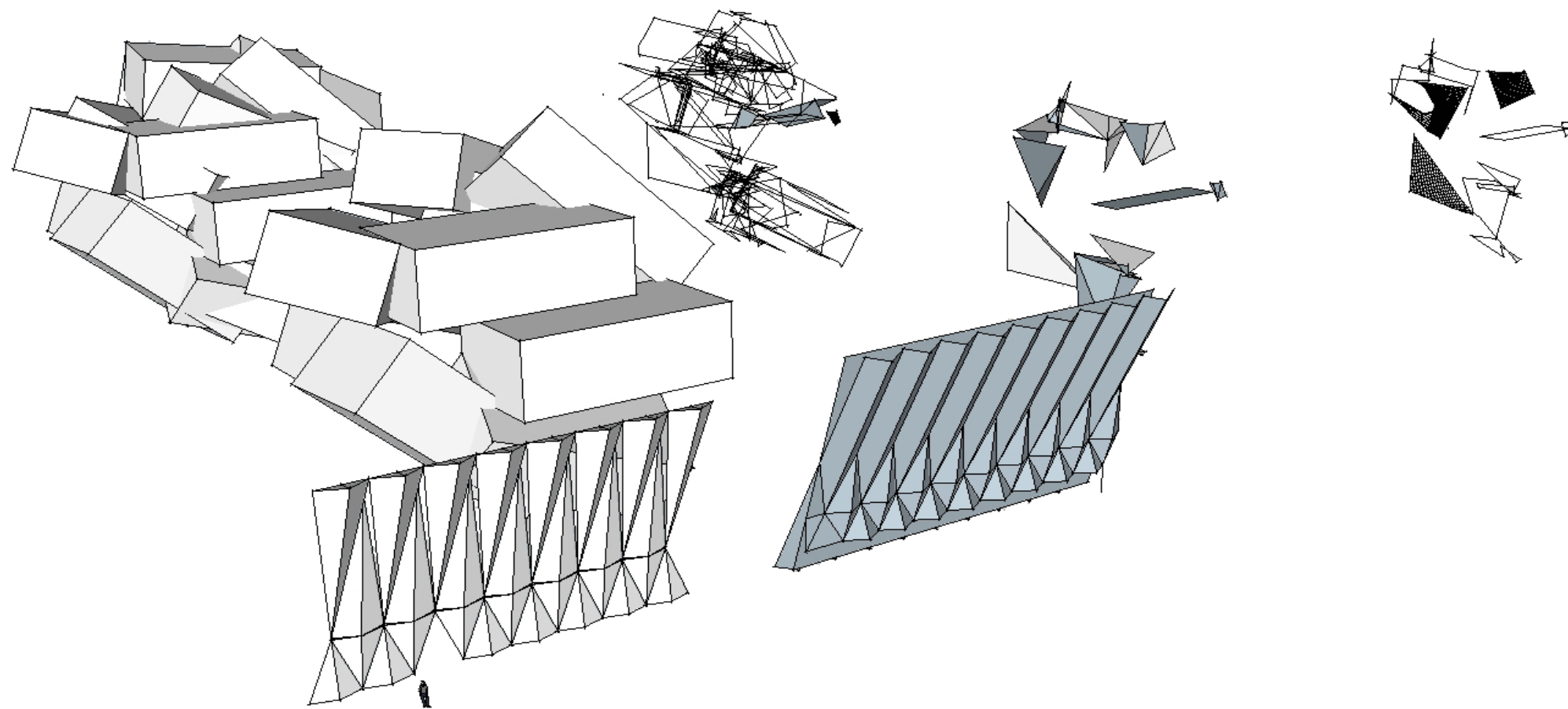

DEVELOPMENT

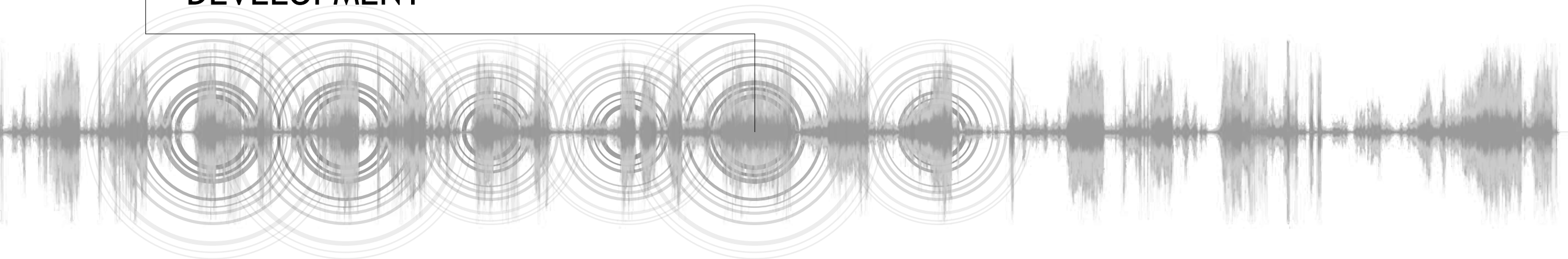

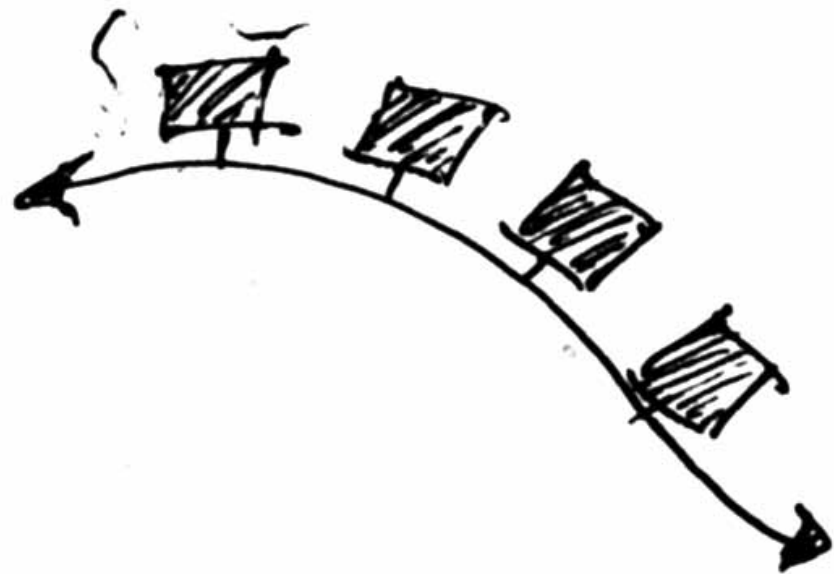

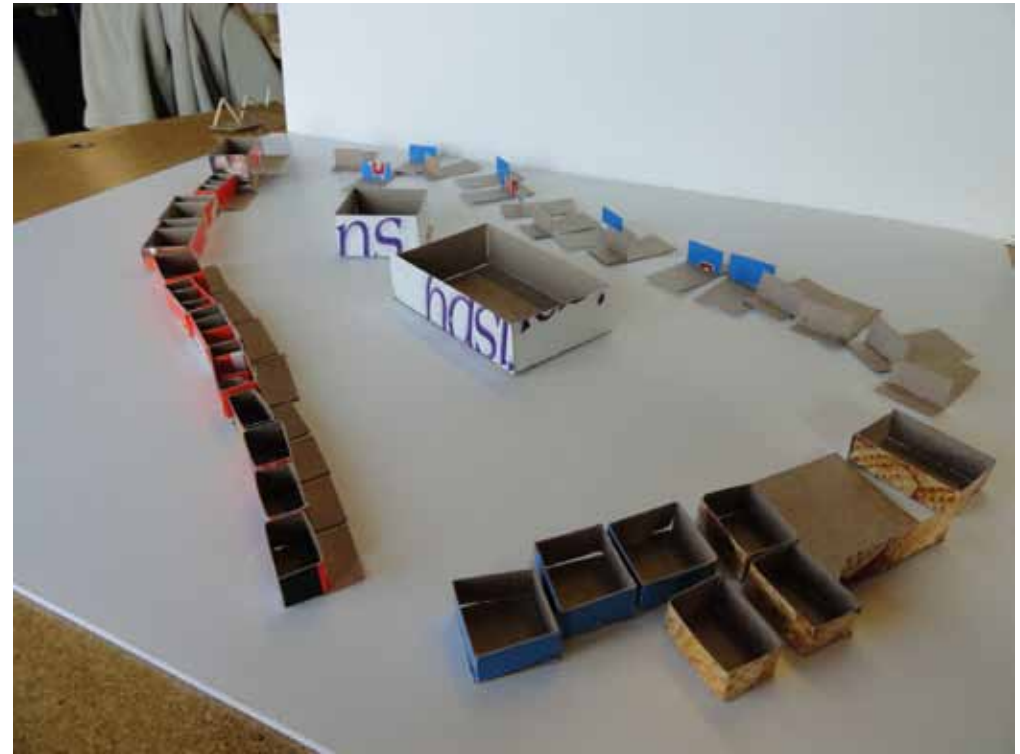
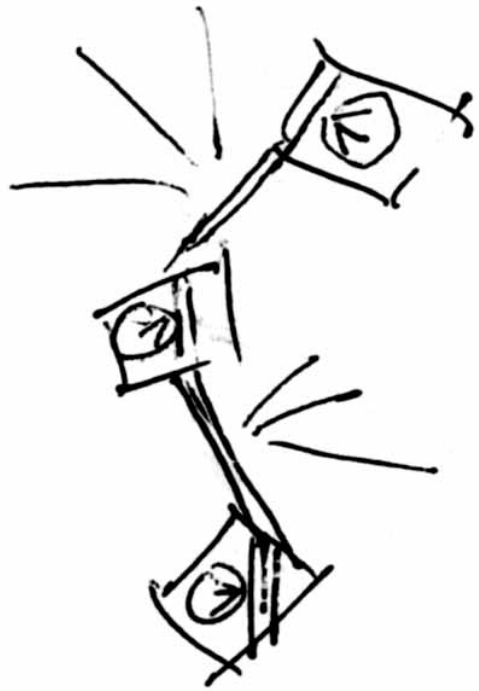
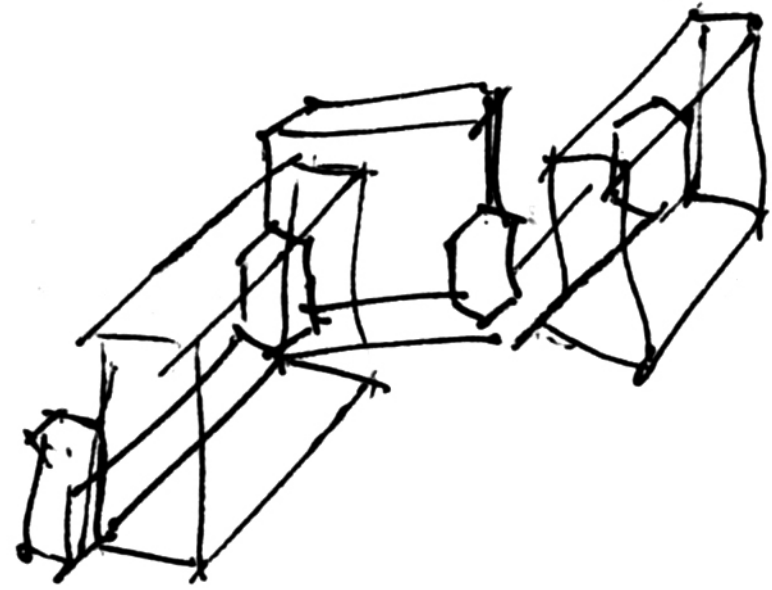

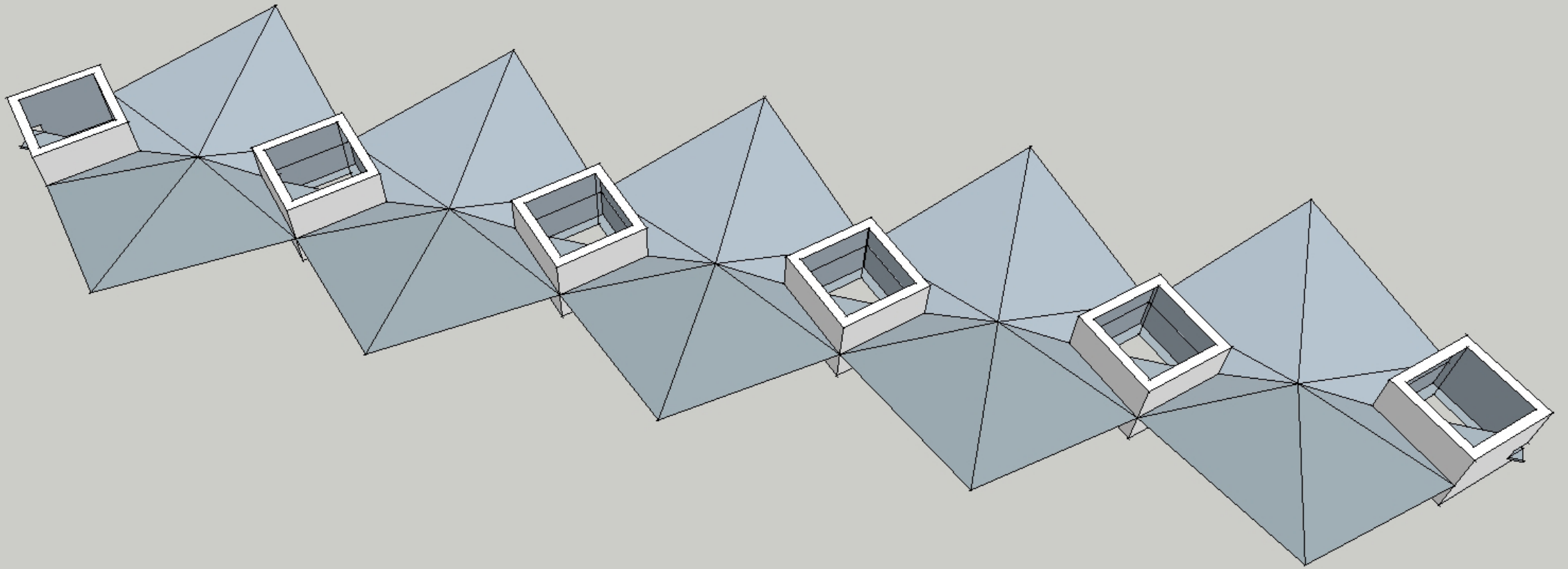
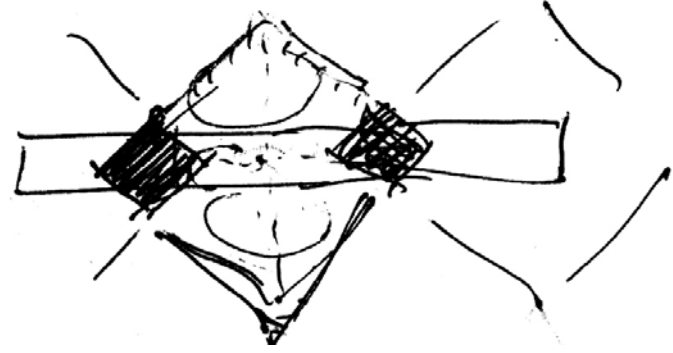
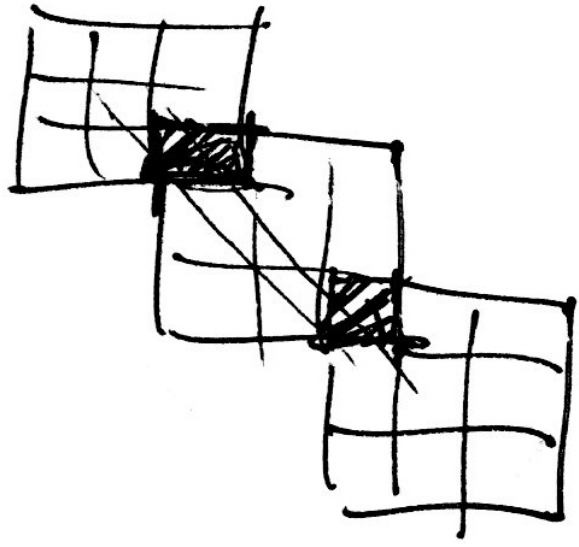

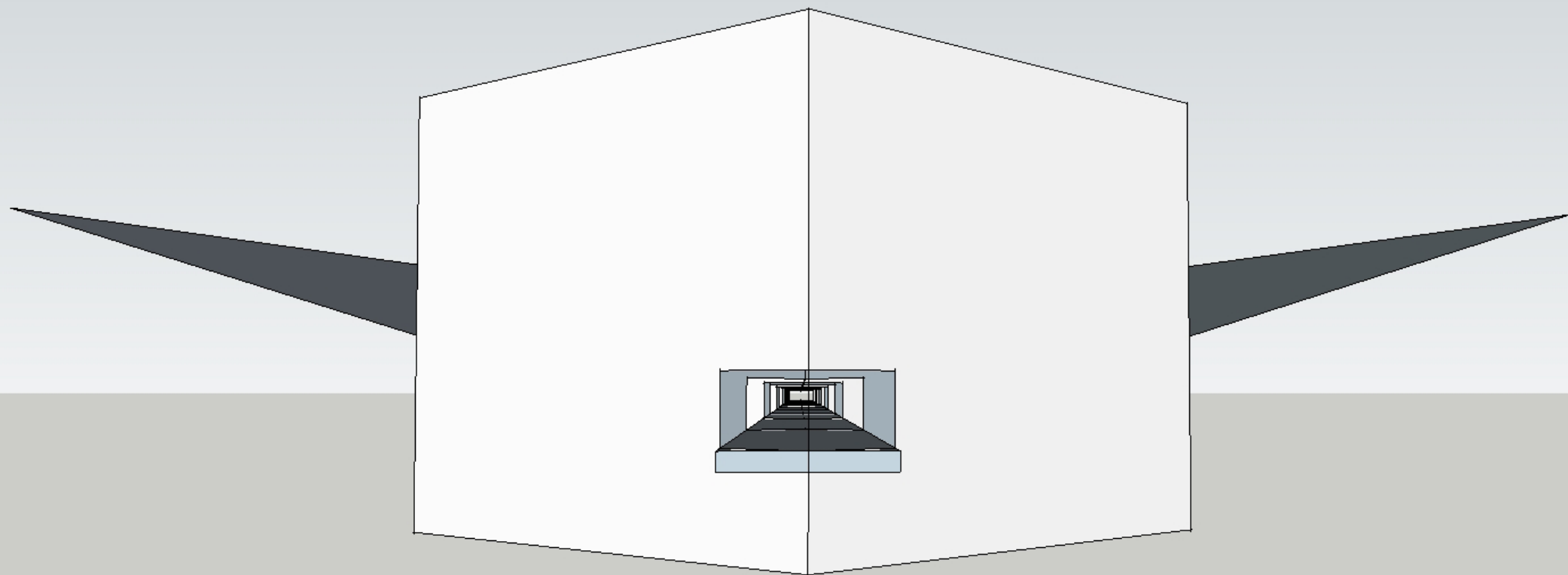
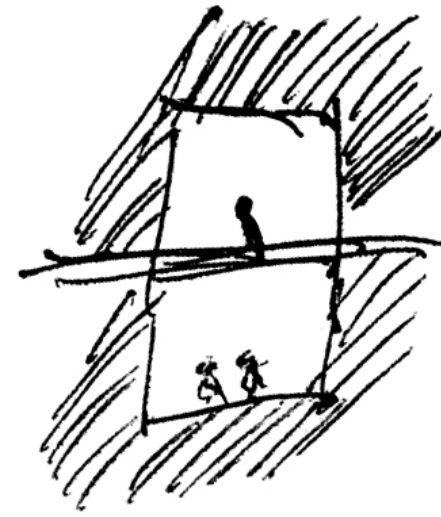

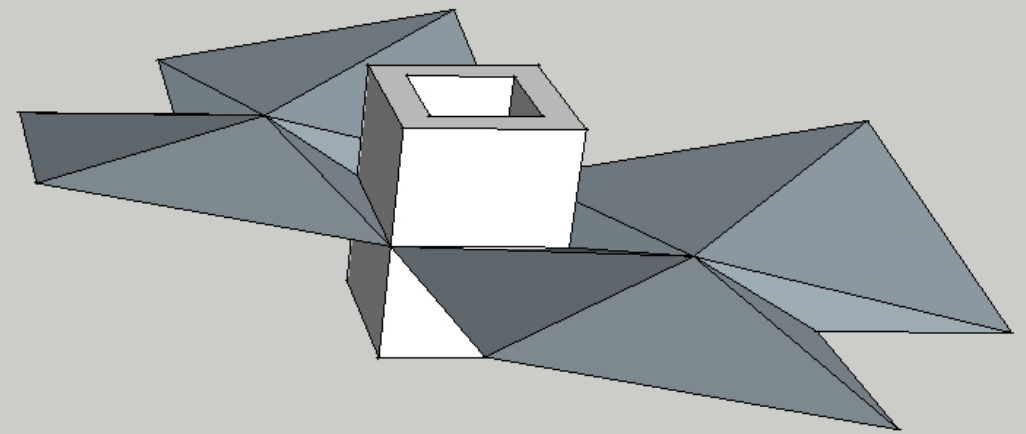
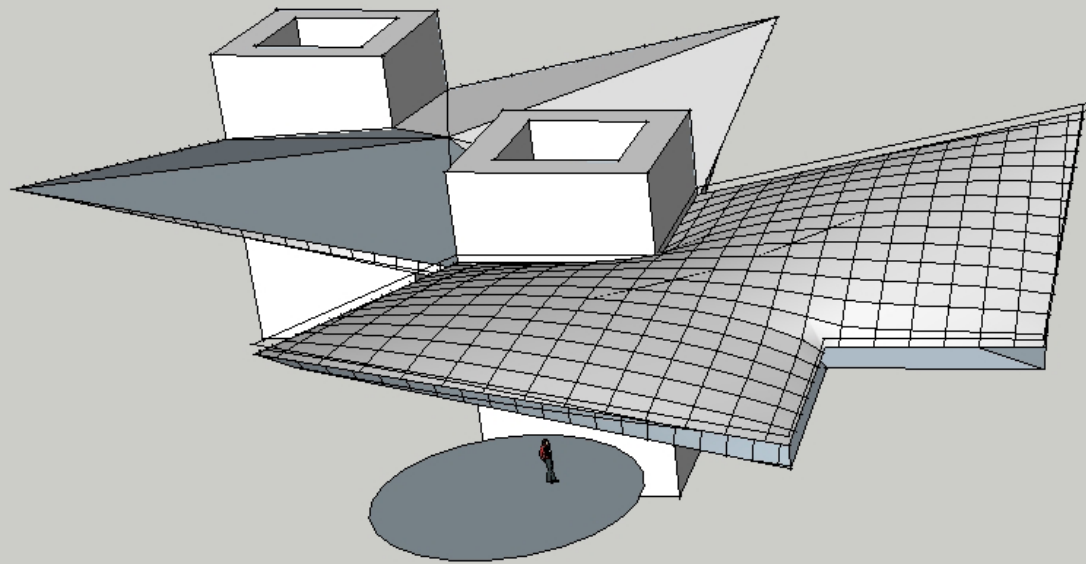

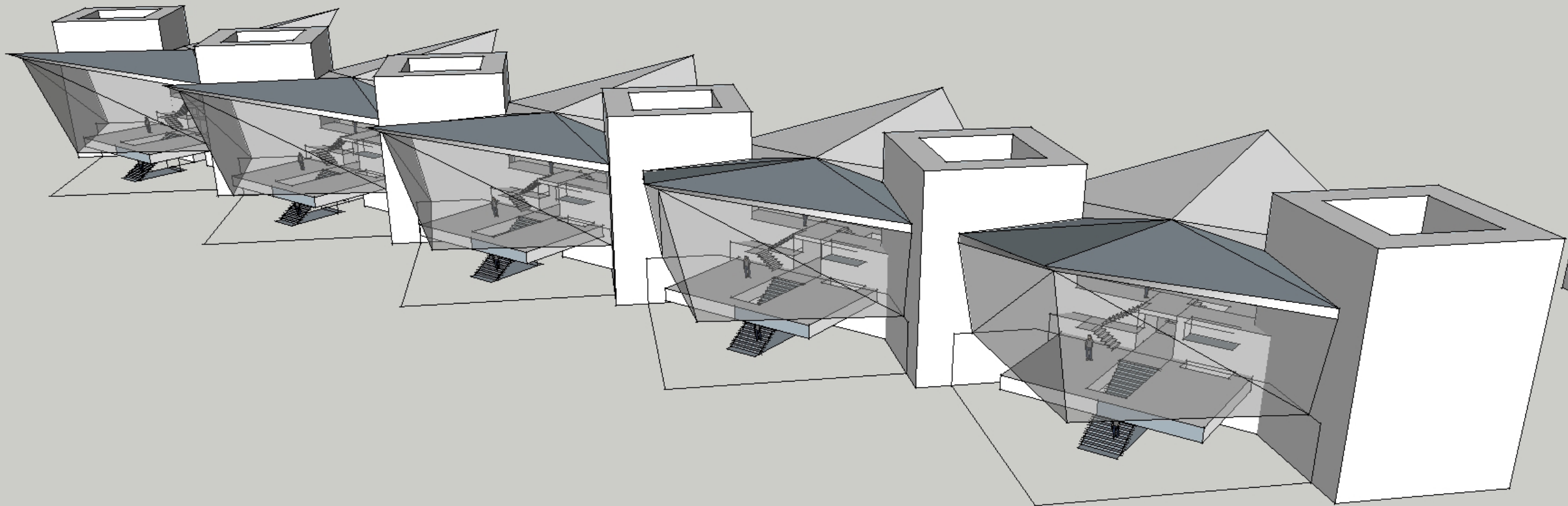
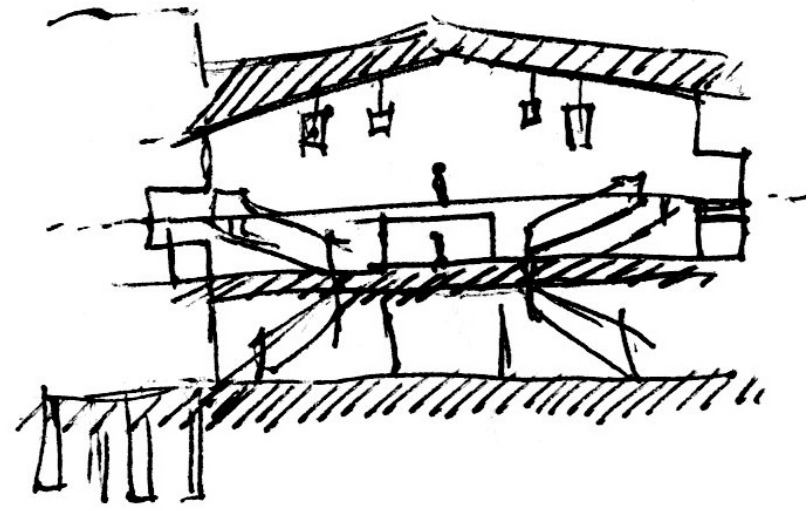
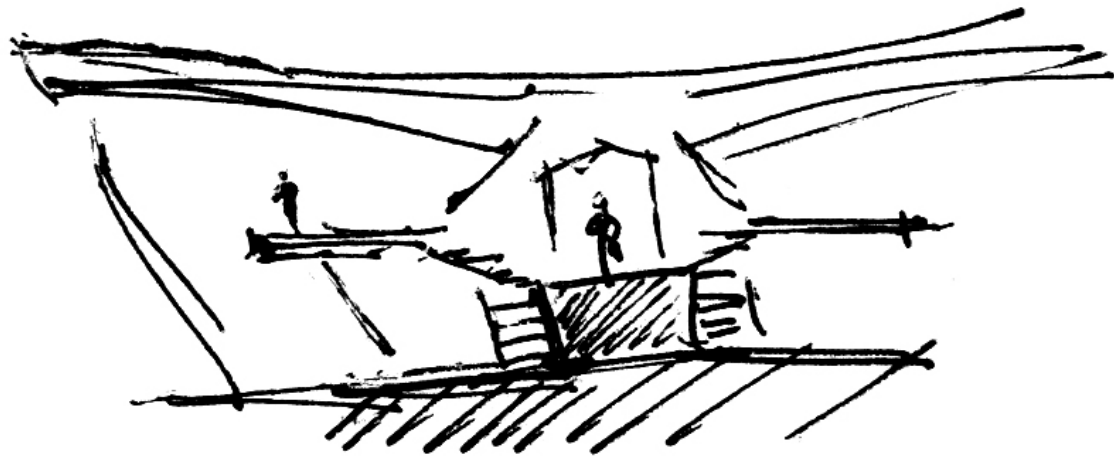

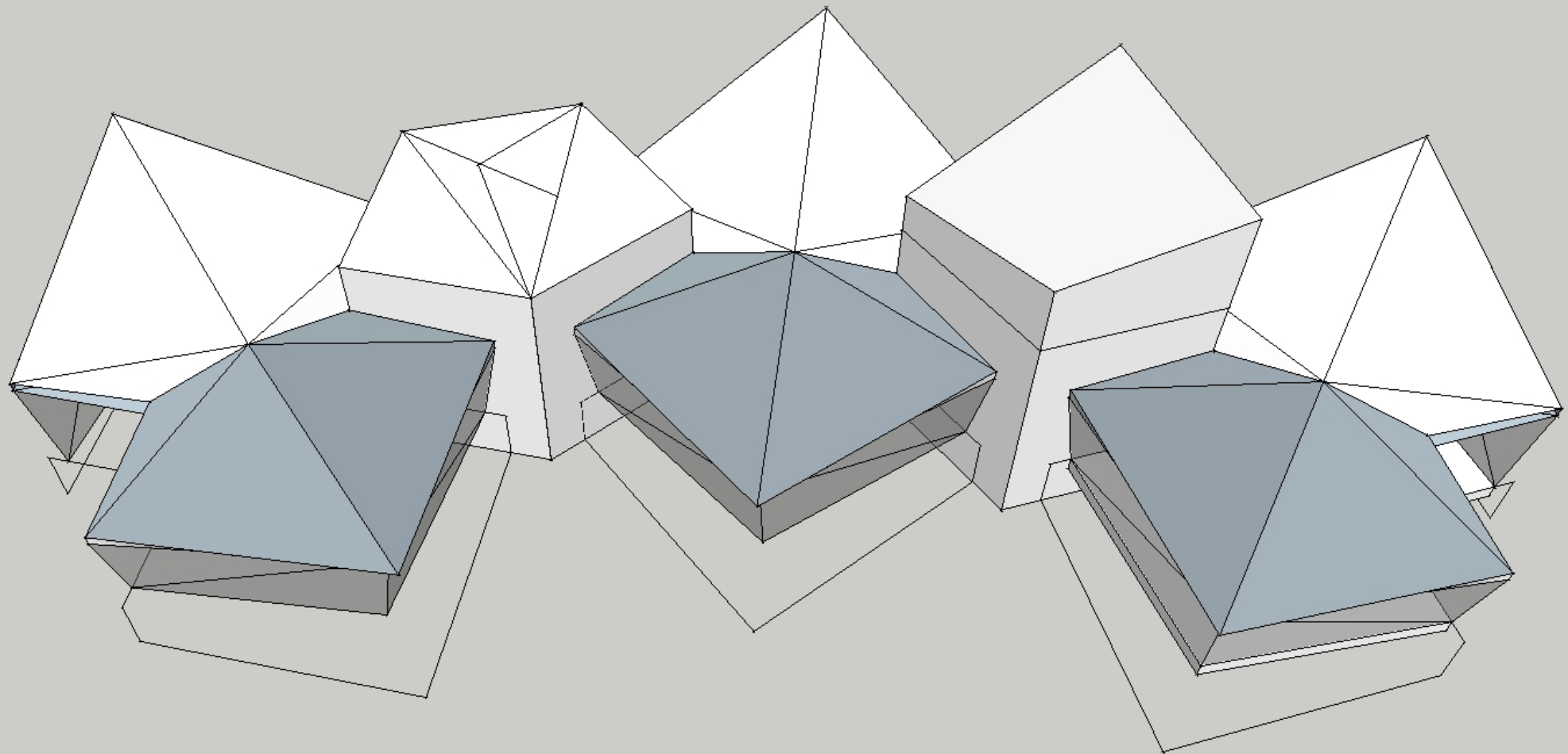
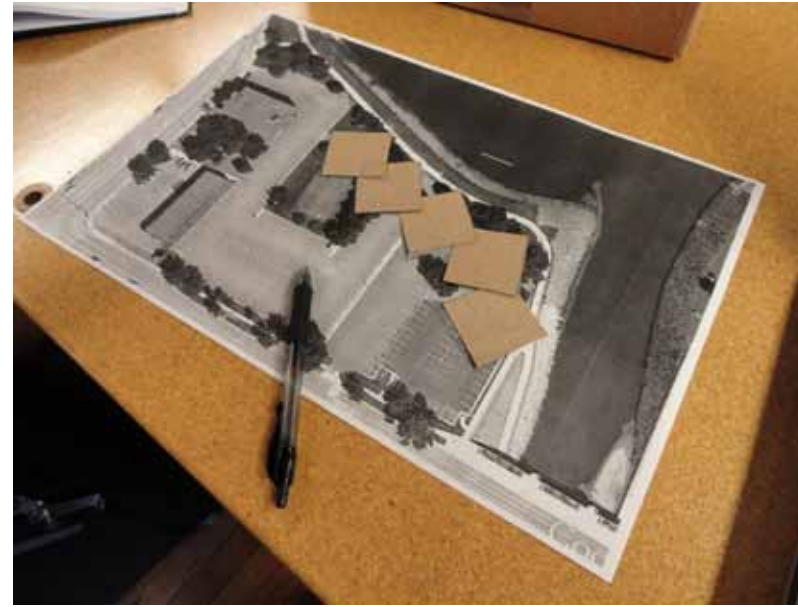
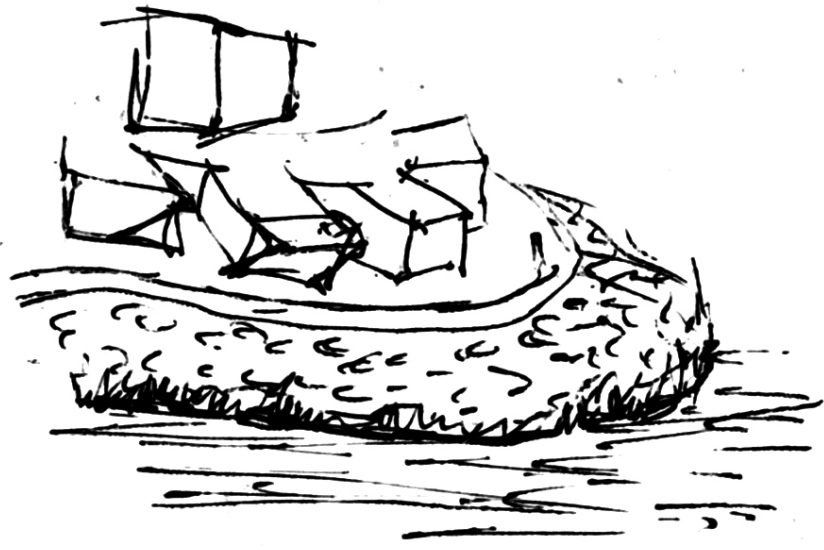

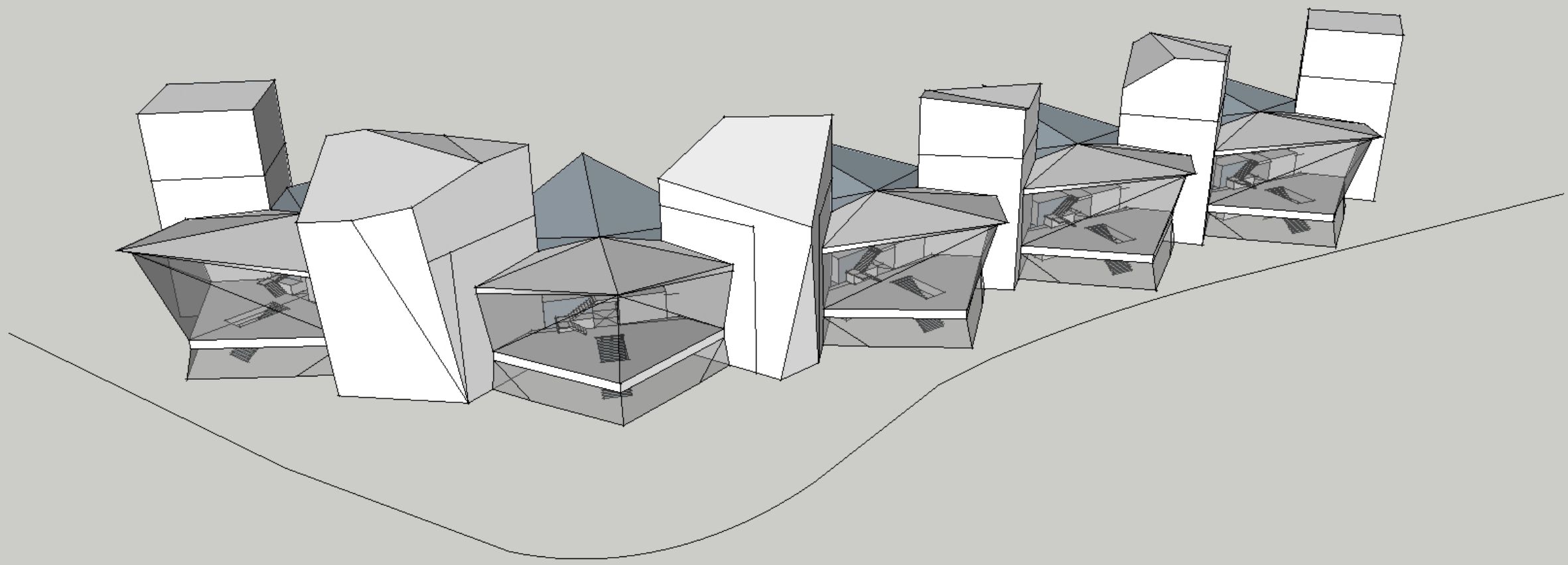
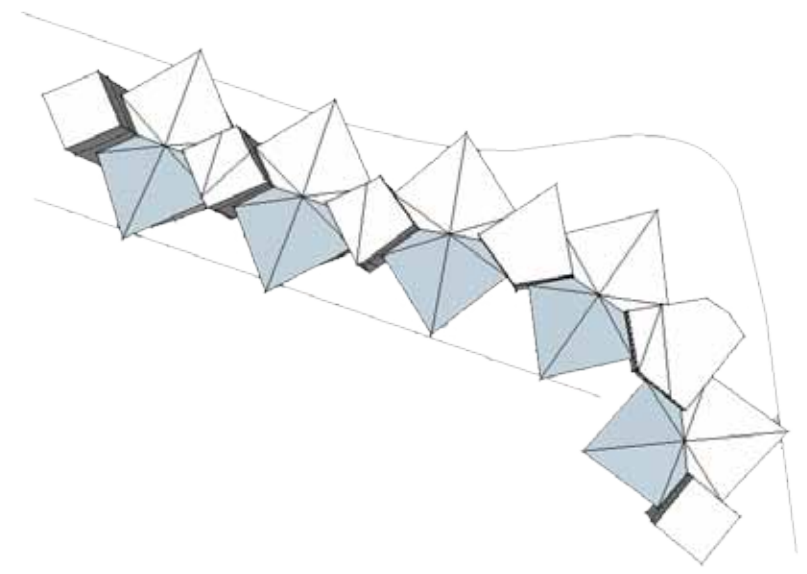
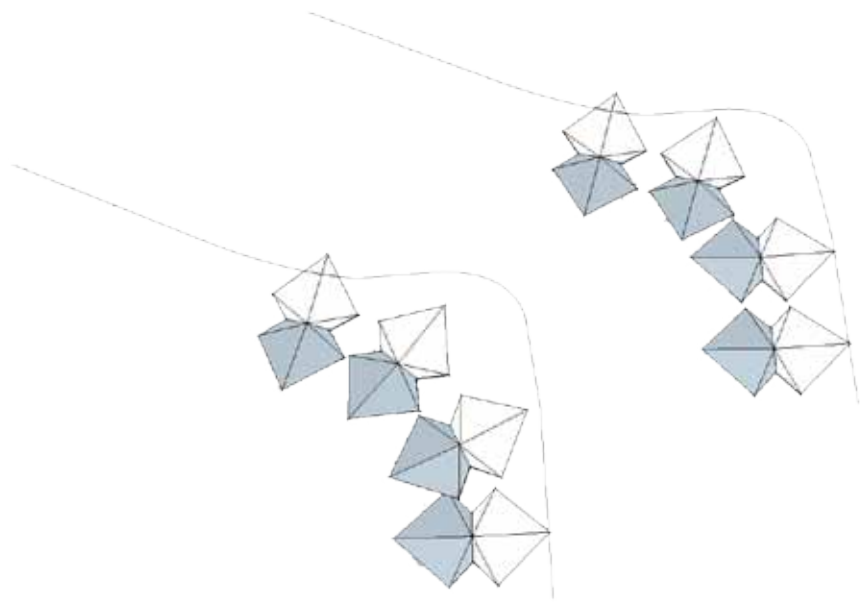



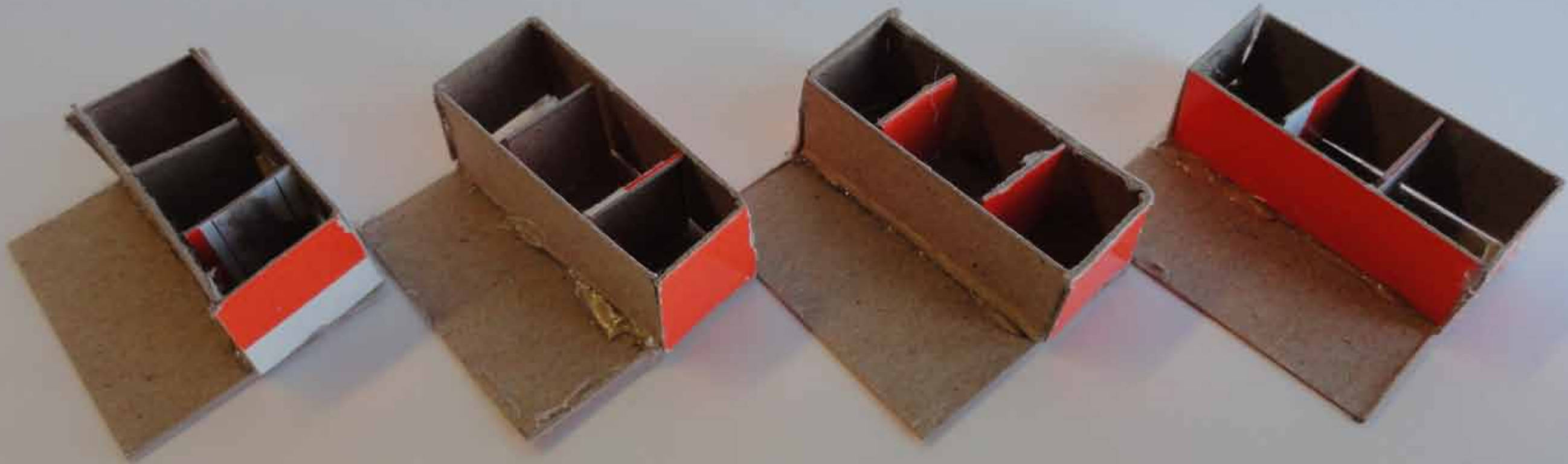
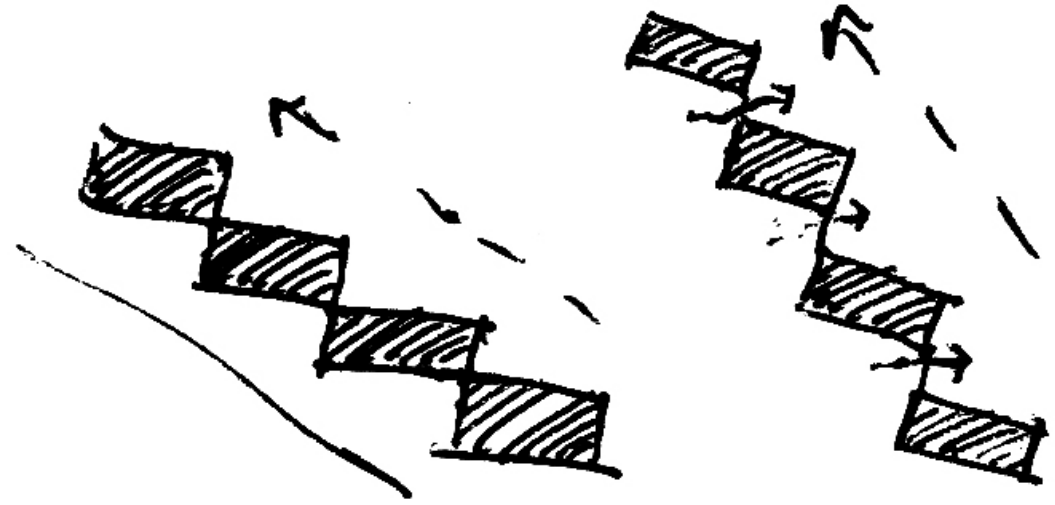

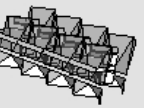
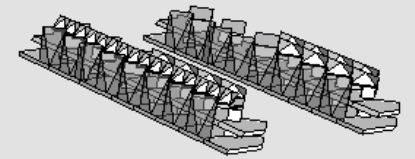
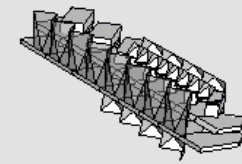
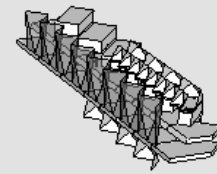
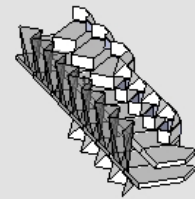
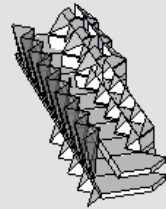
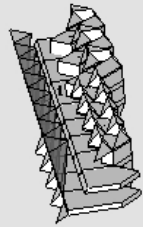
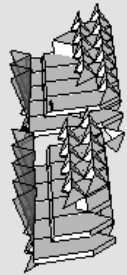
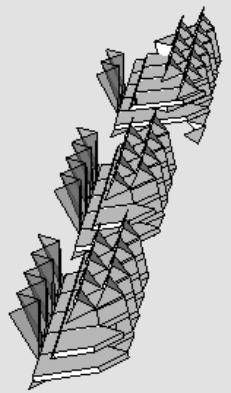
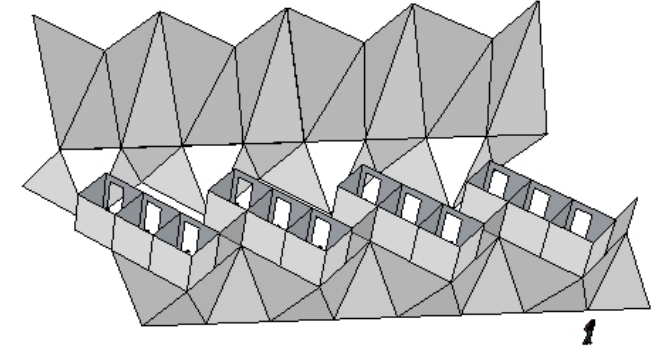
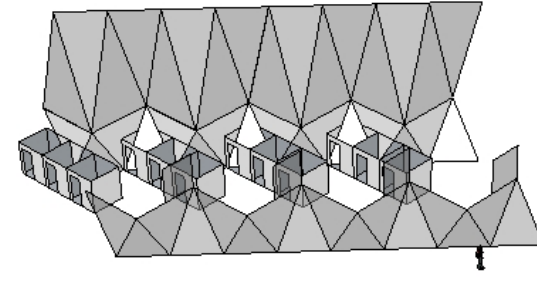
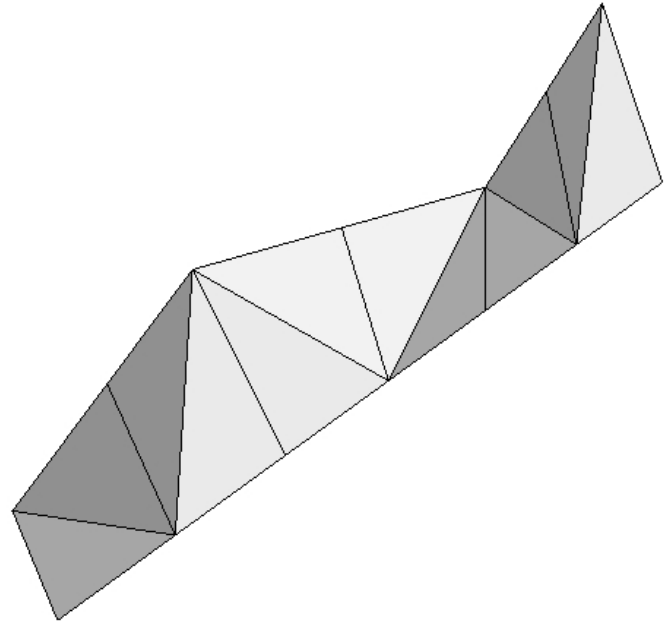

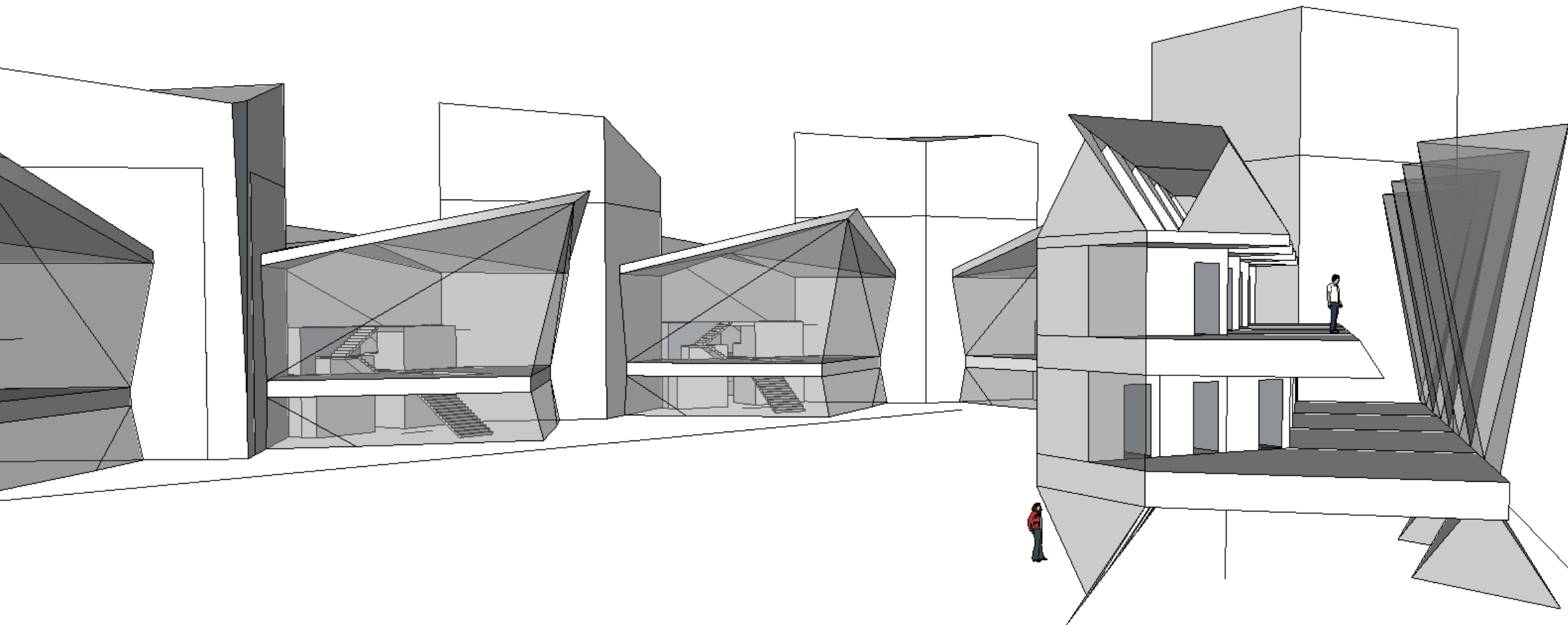
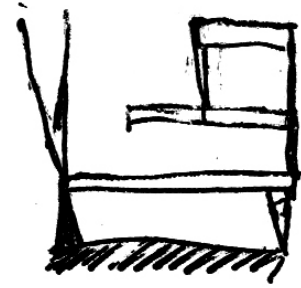
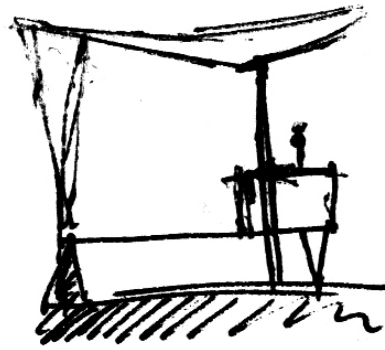

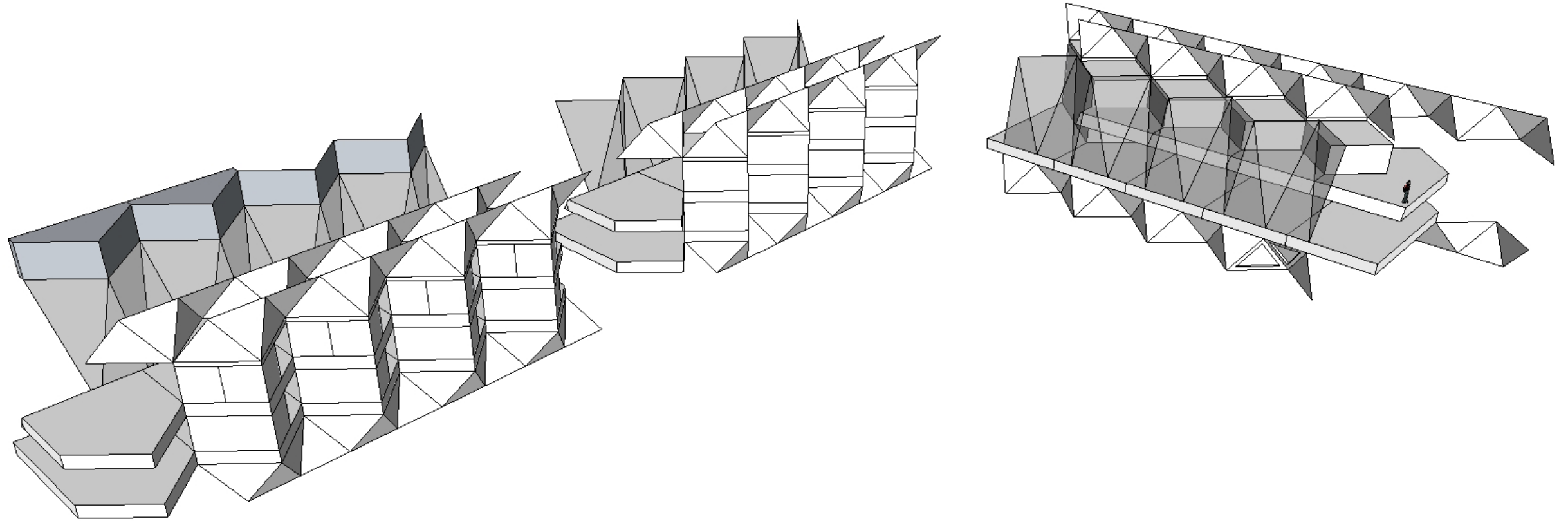
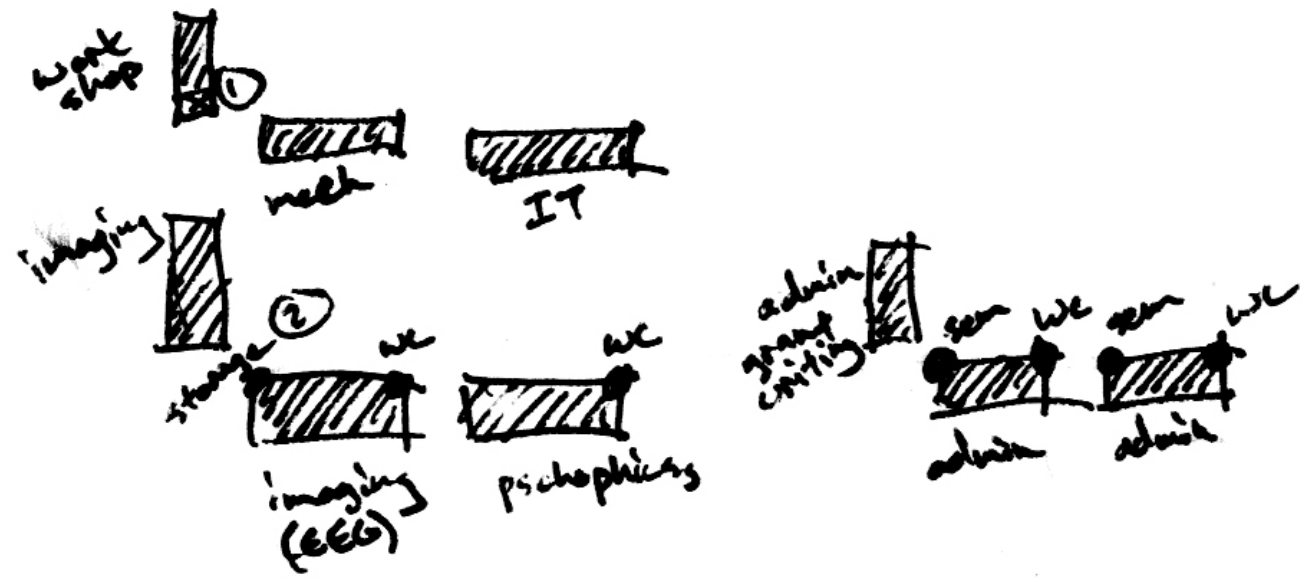

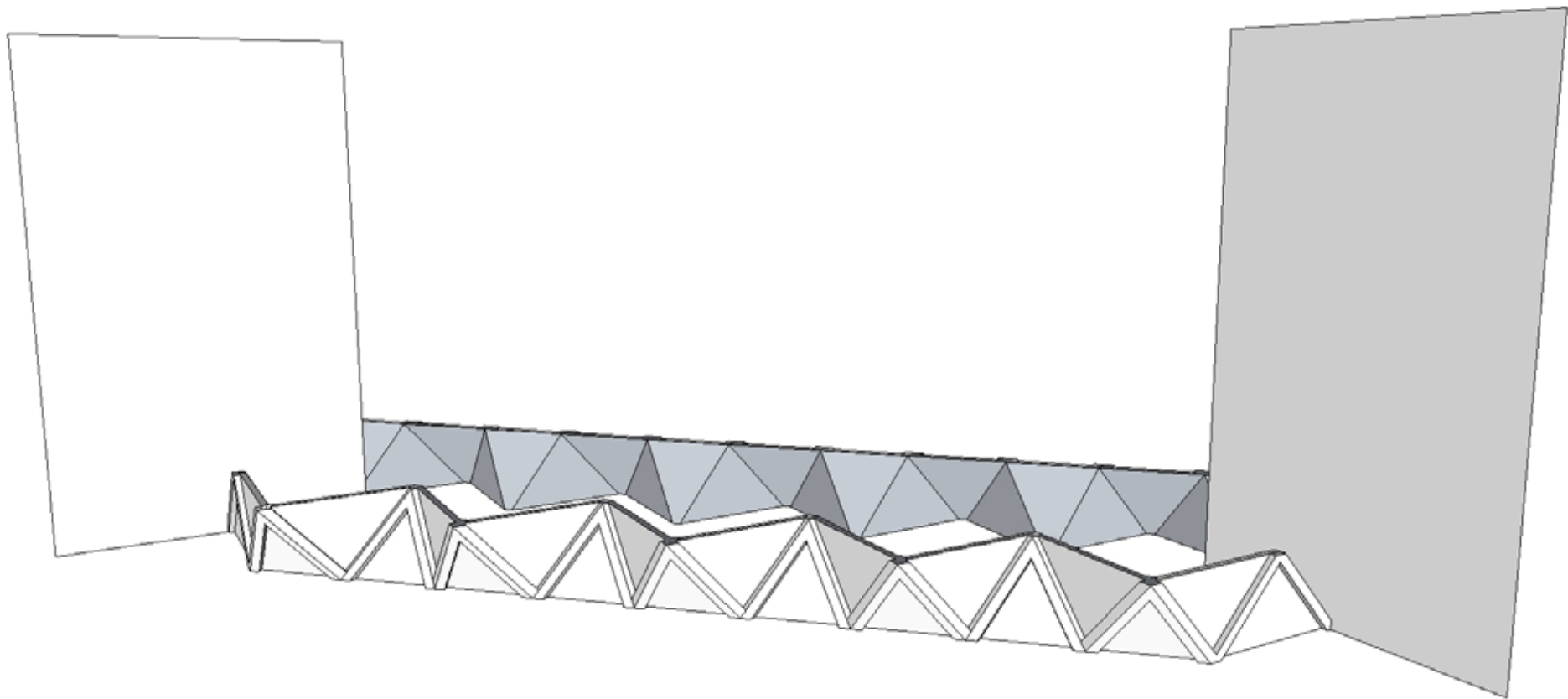
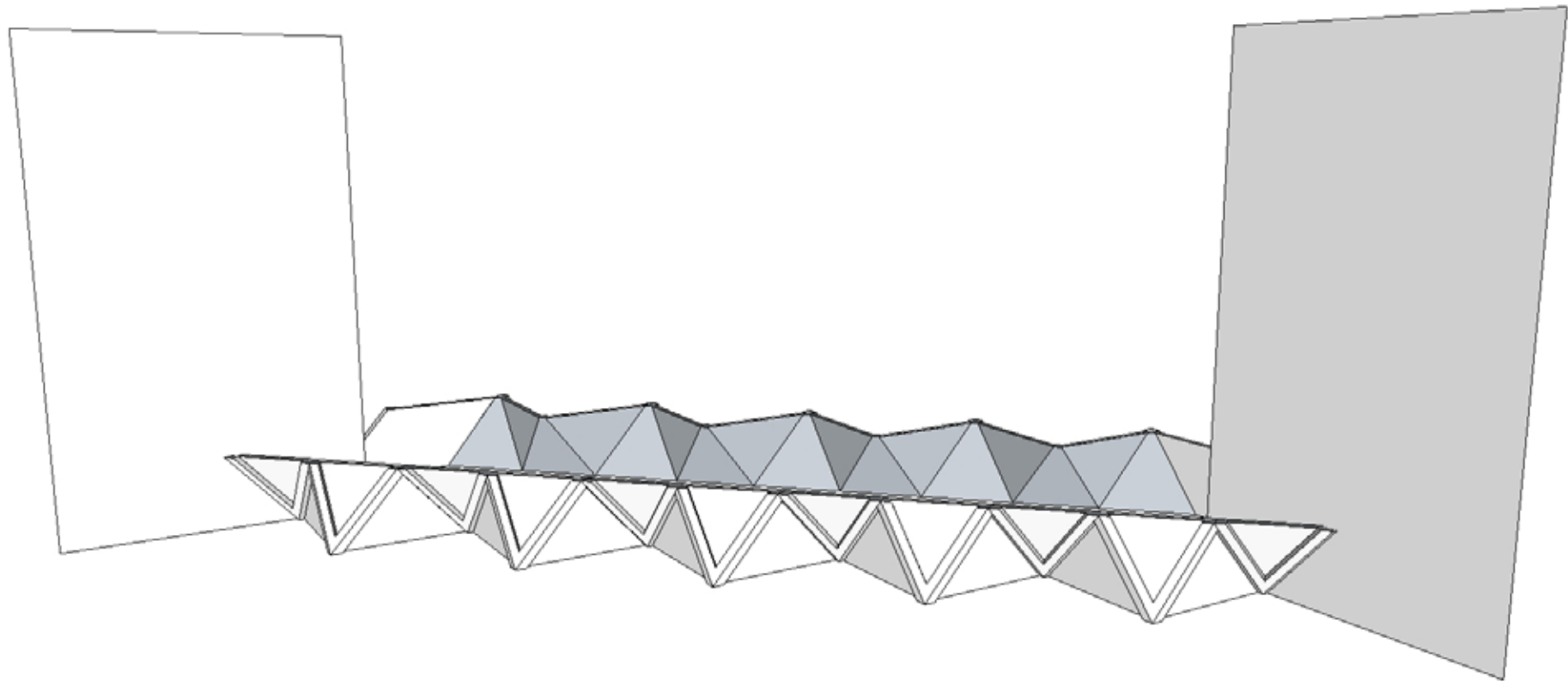

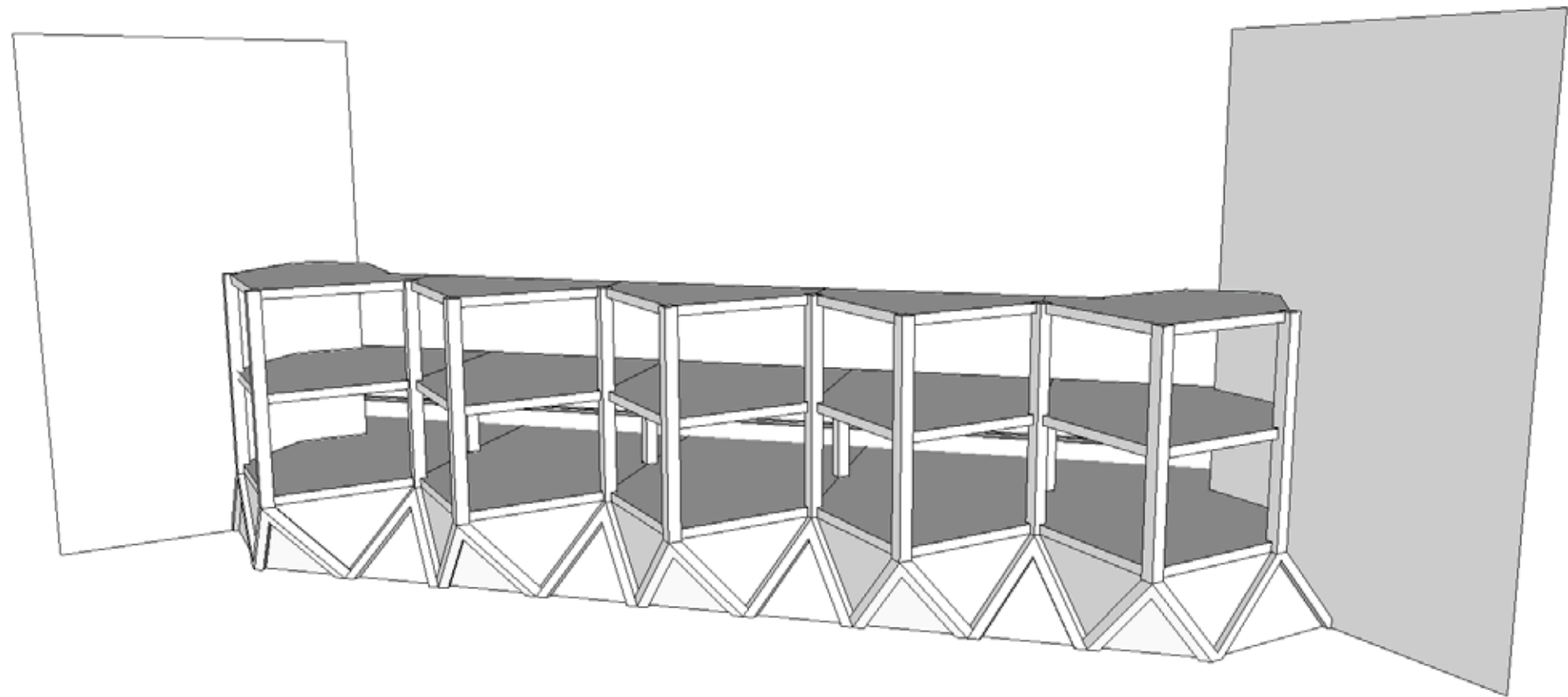
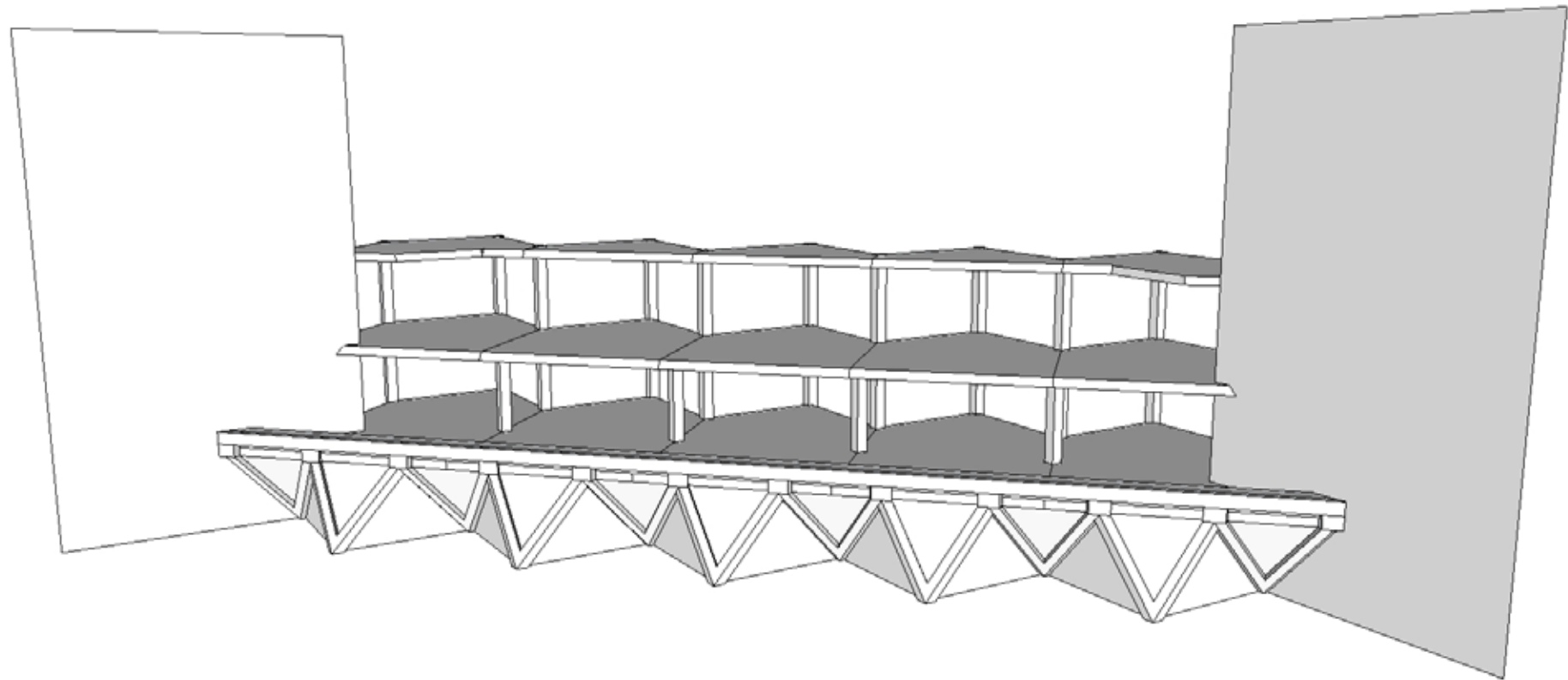

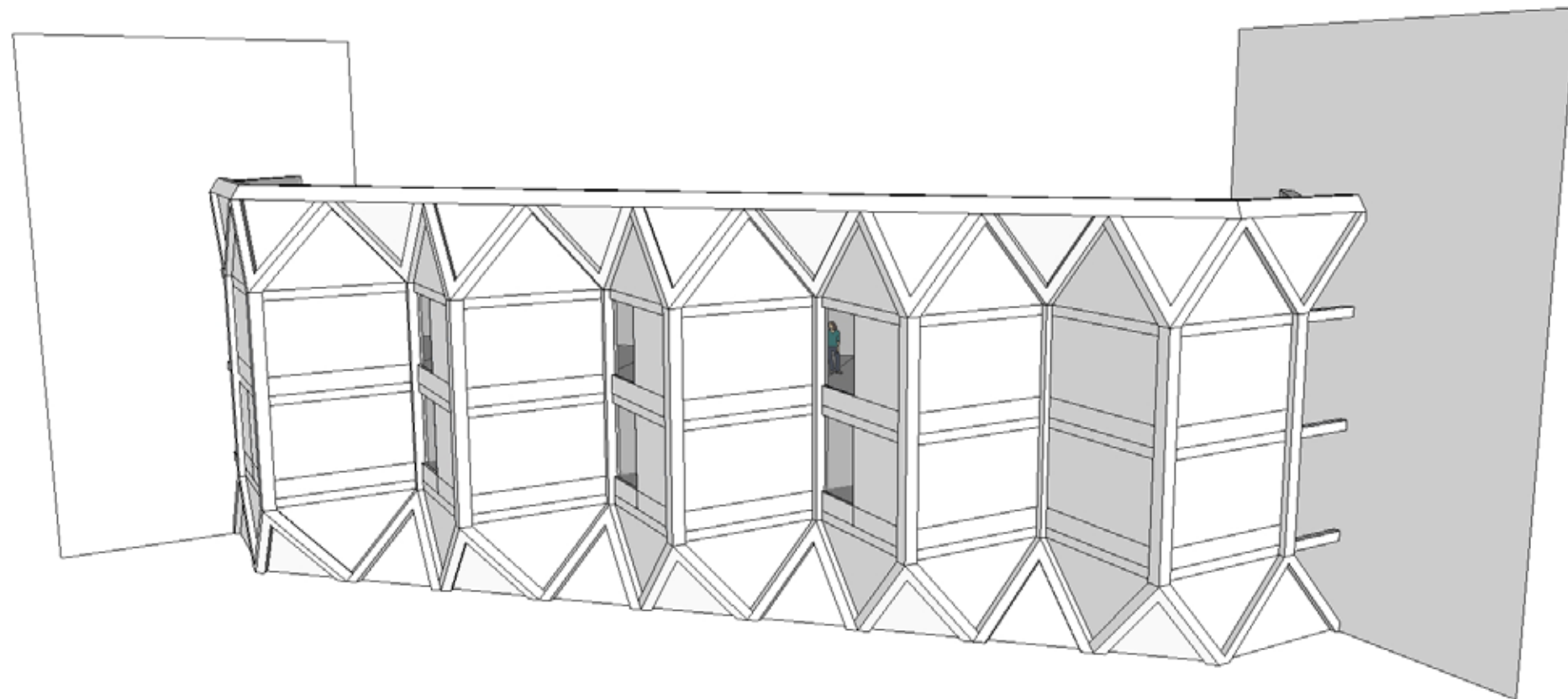
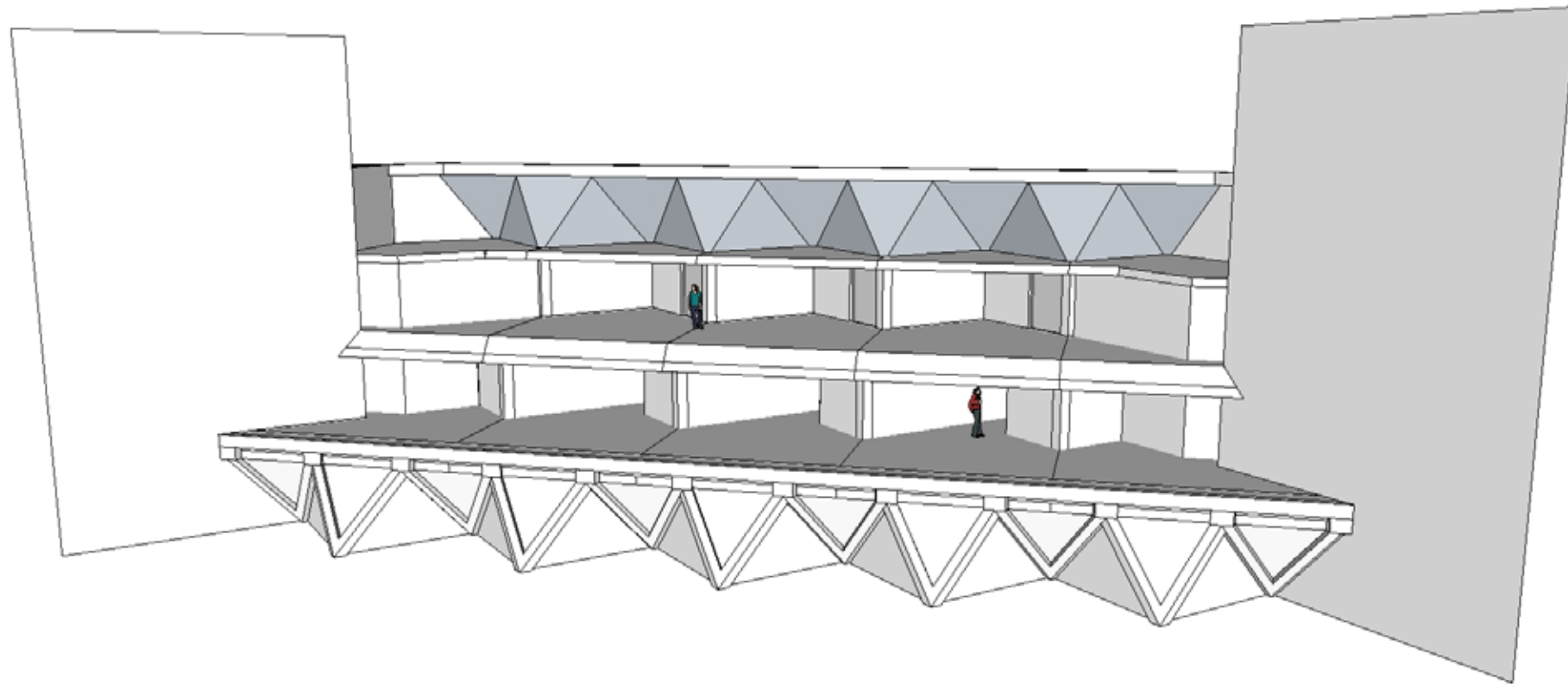

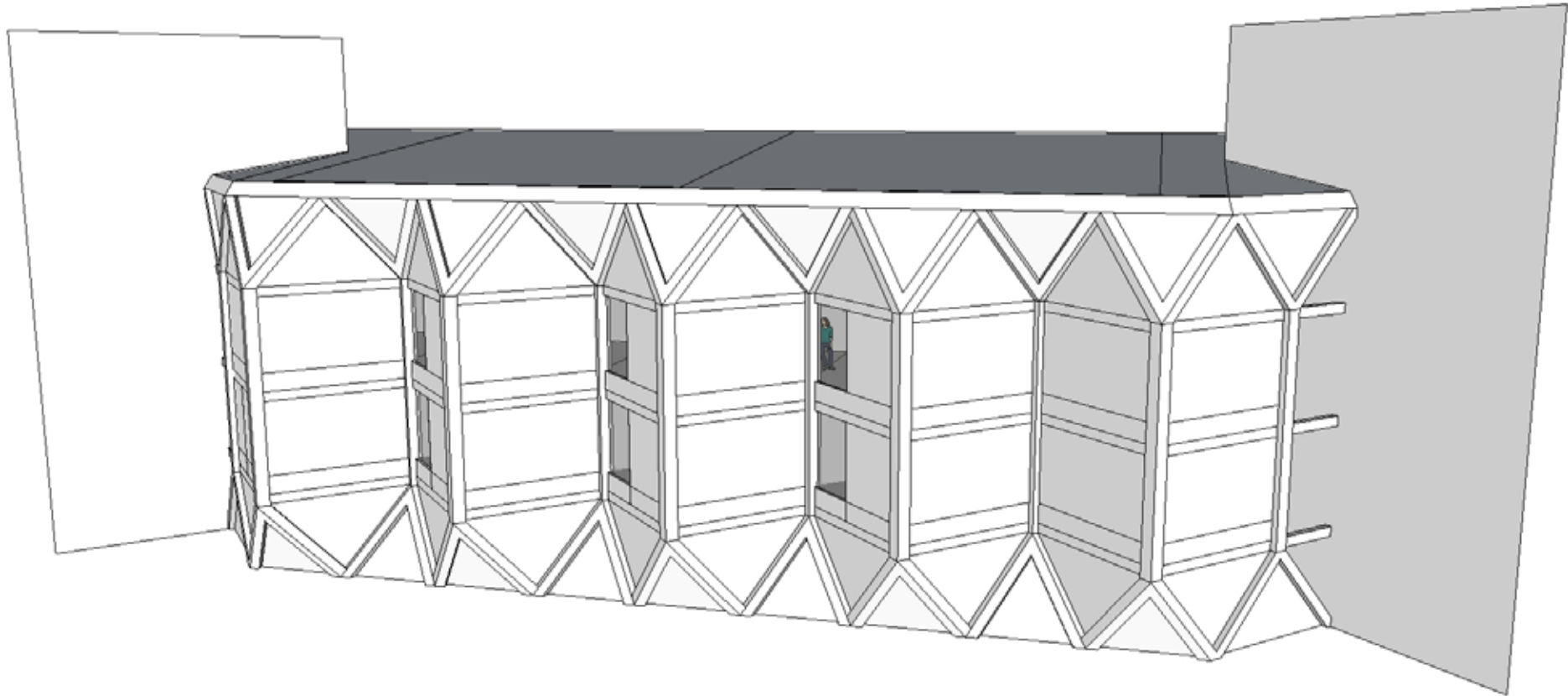
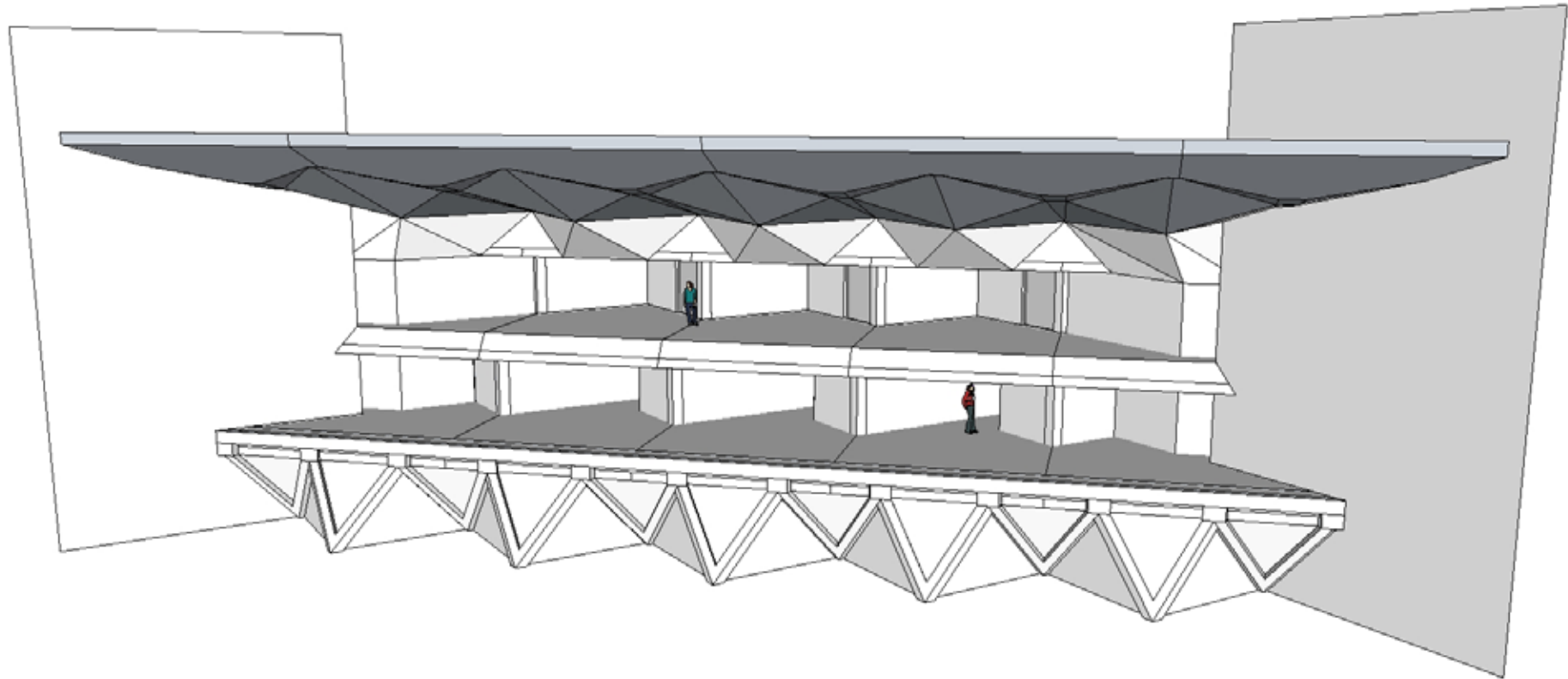

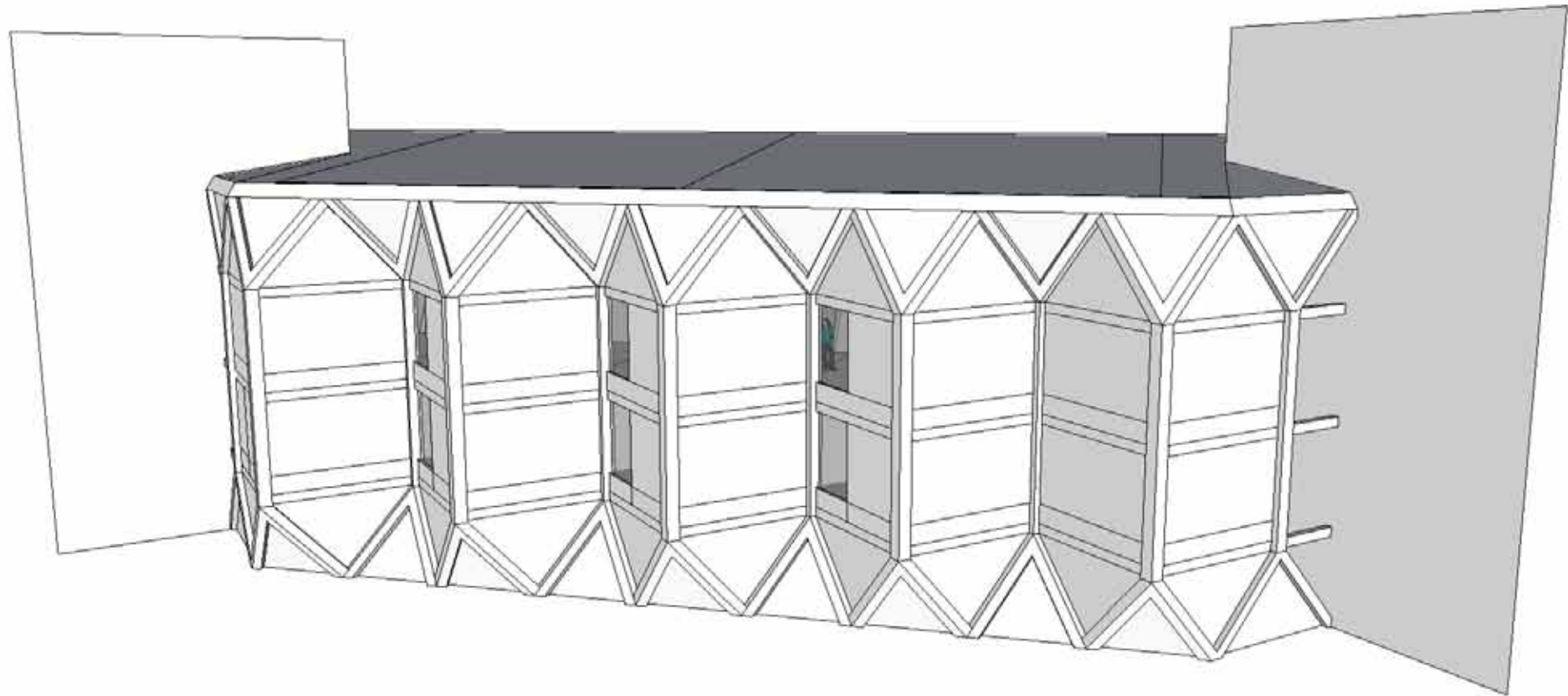
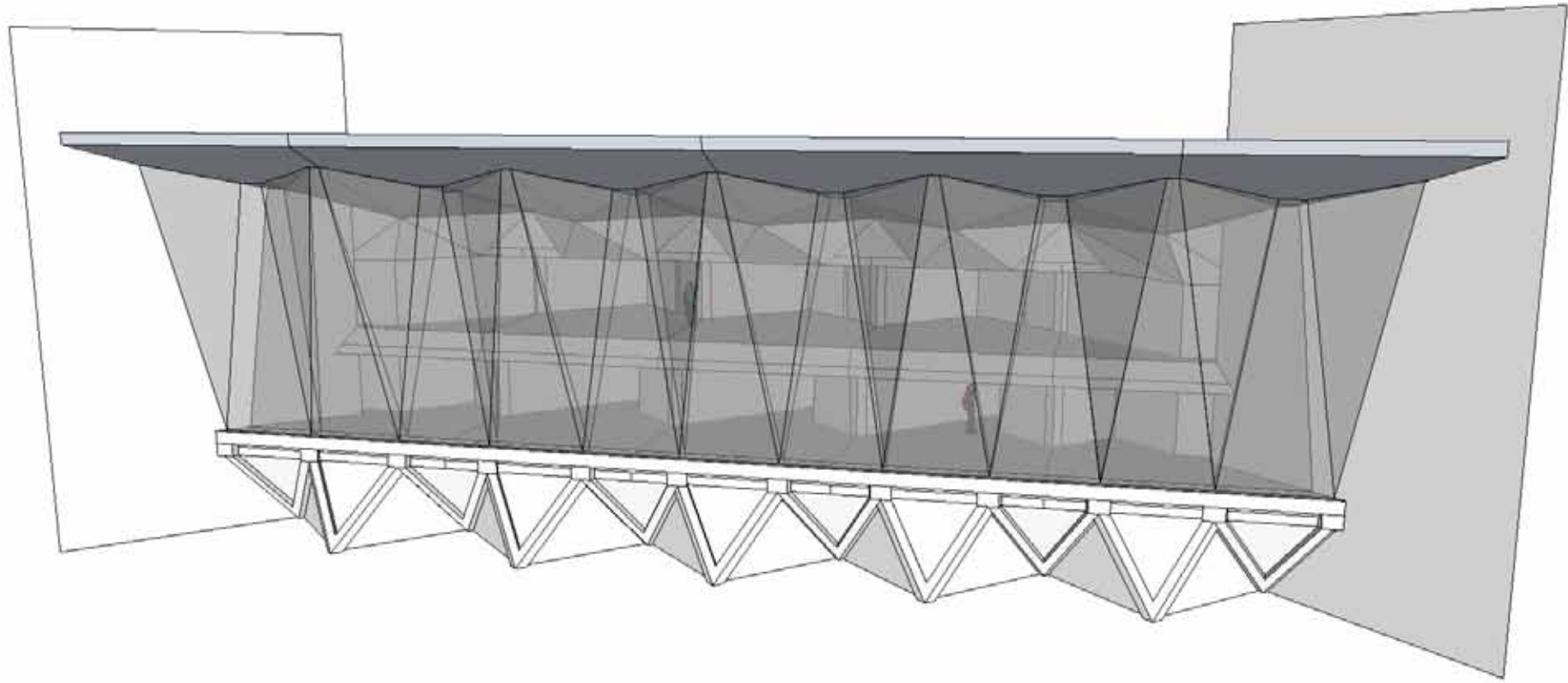

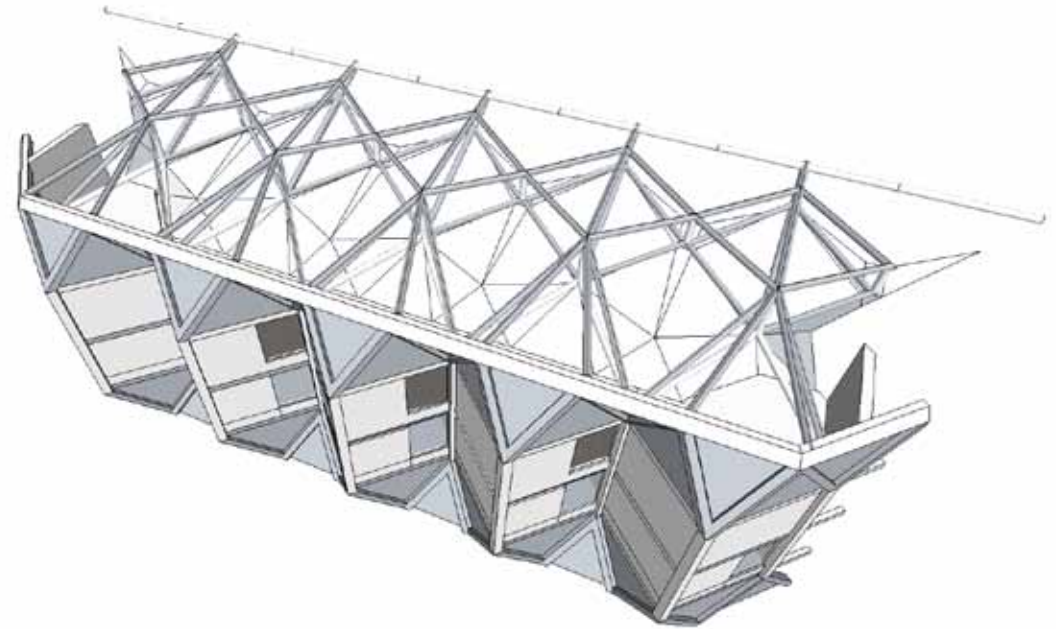
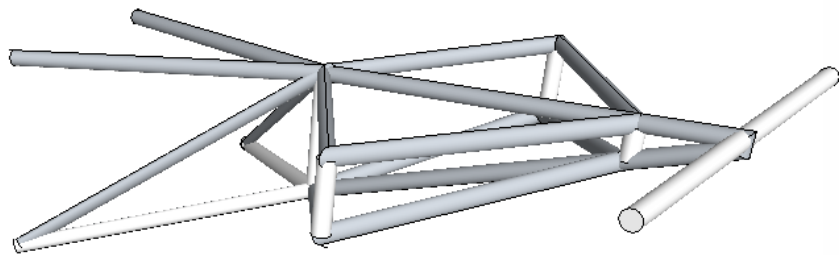
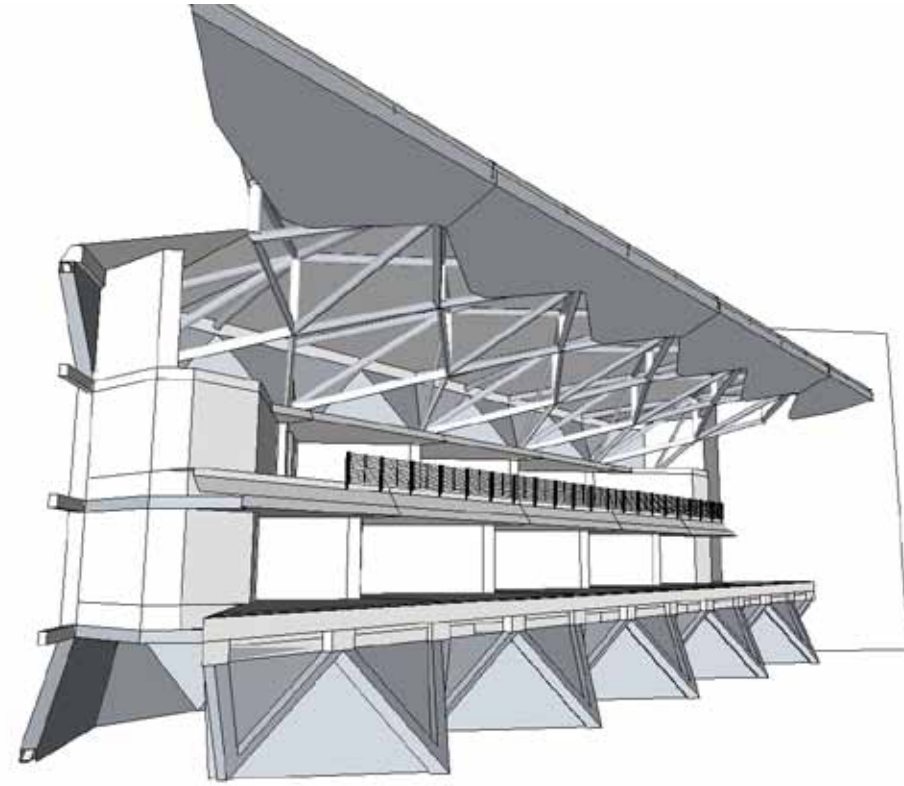
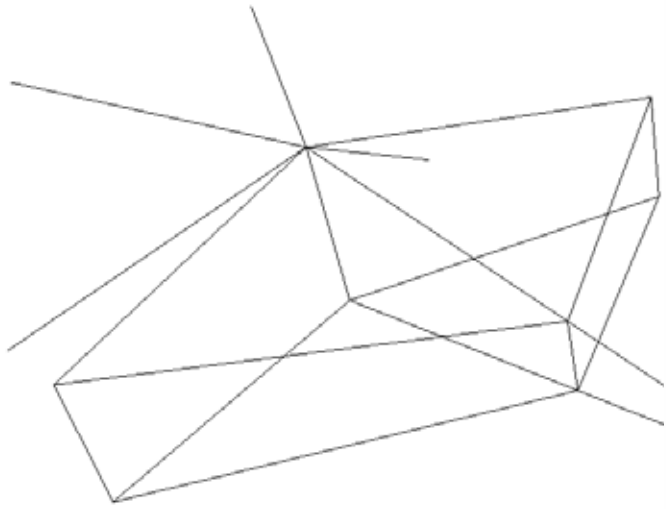

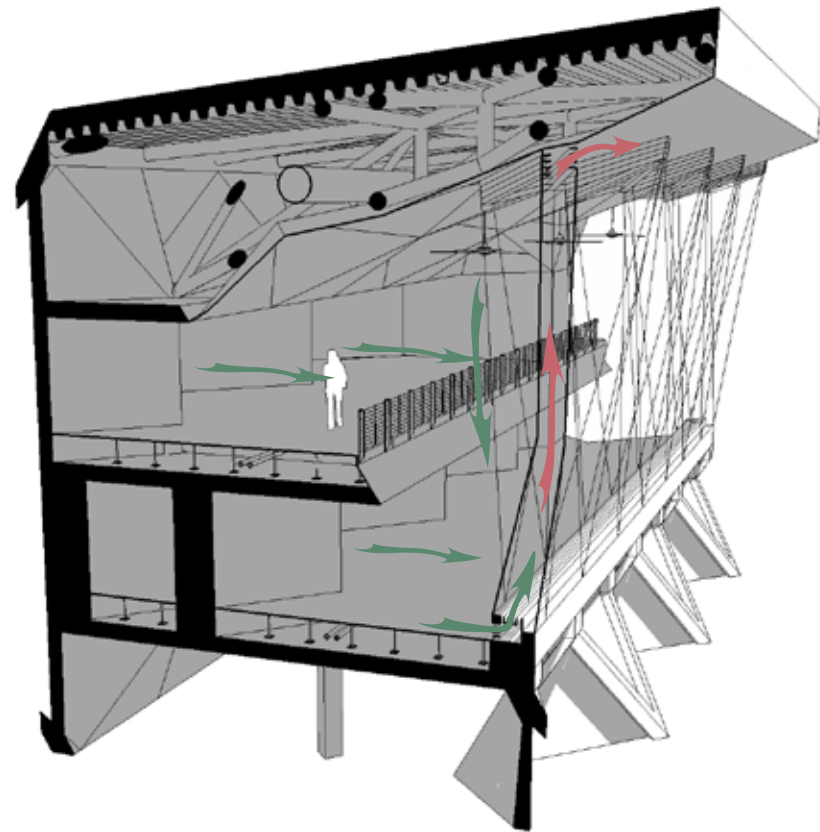
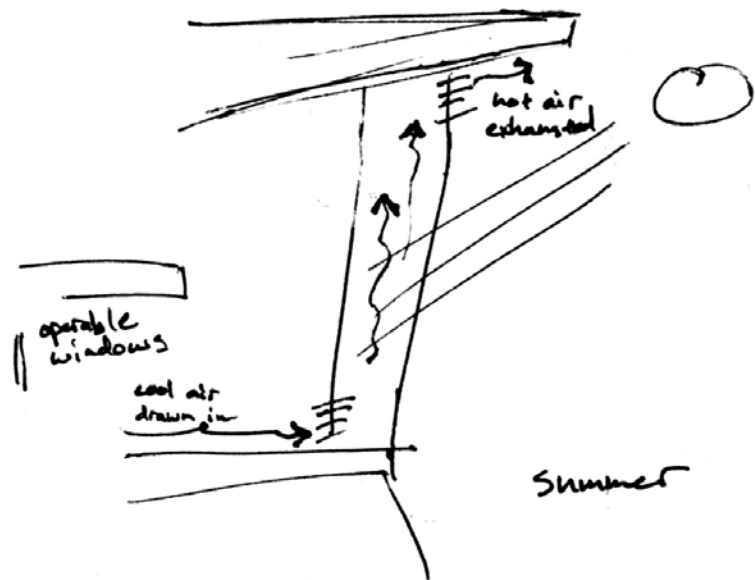
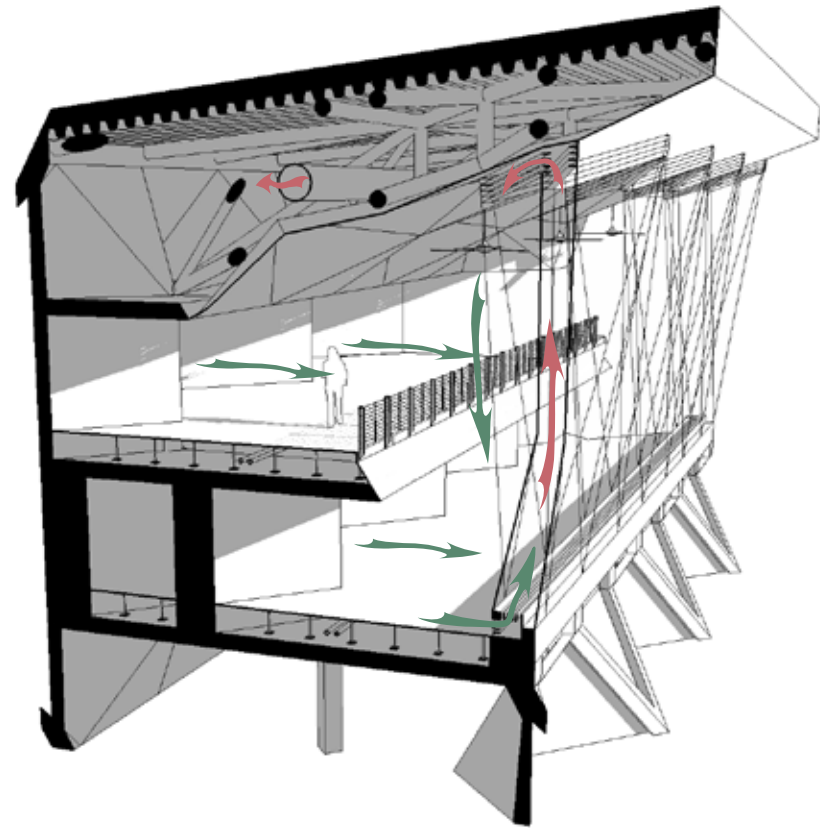
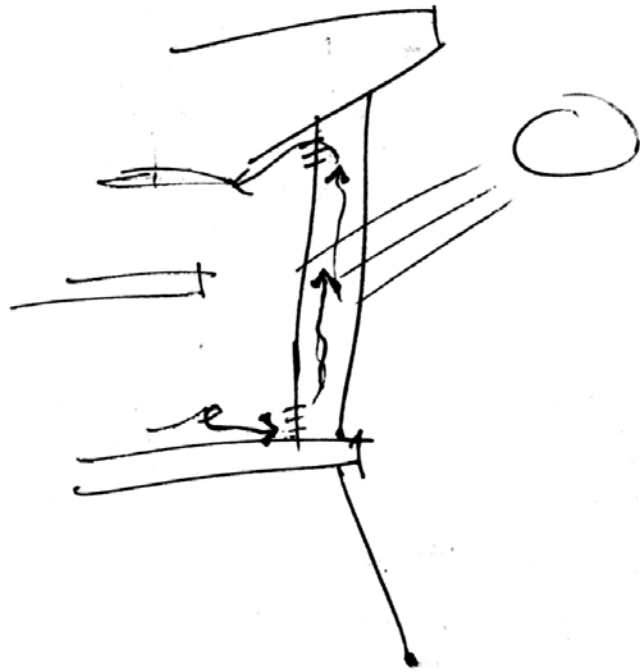



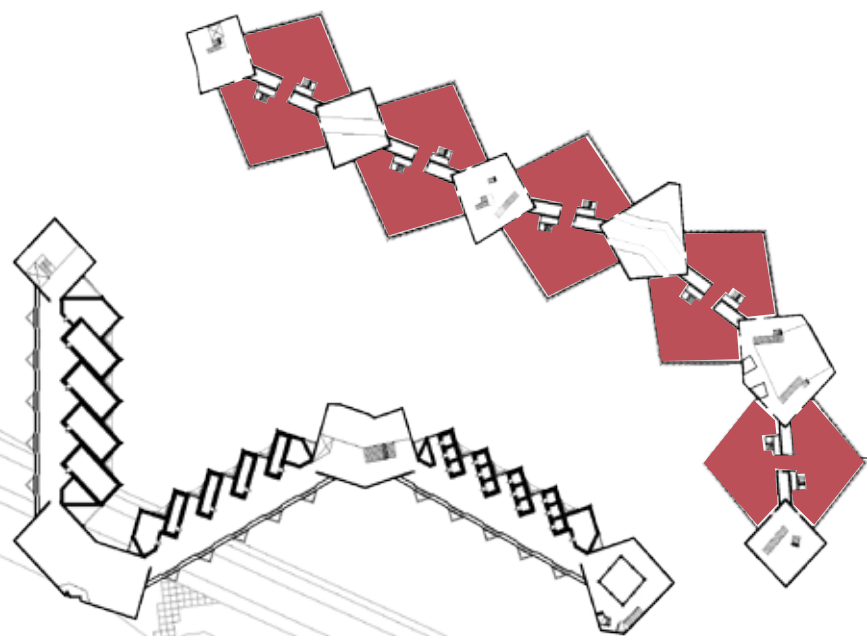
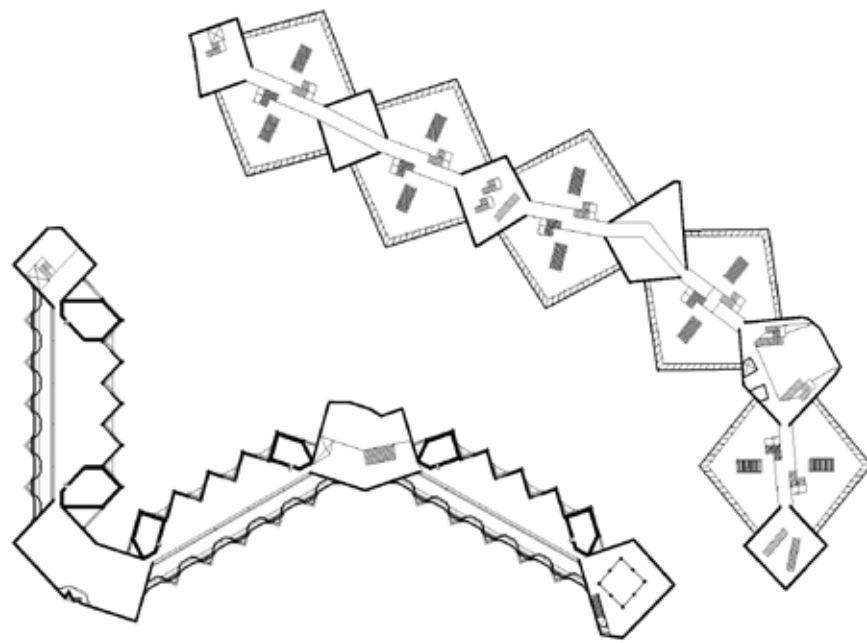

RESEARCH WORKSPACES

16 team workspaces

1 library

LABORATORIES

12 headphone booths

4 EEG booths

1 MEG suite

1 fMRI suite

1 synthetic sound field room

1 anechoic chamber

ADMINISTRATION

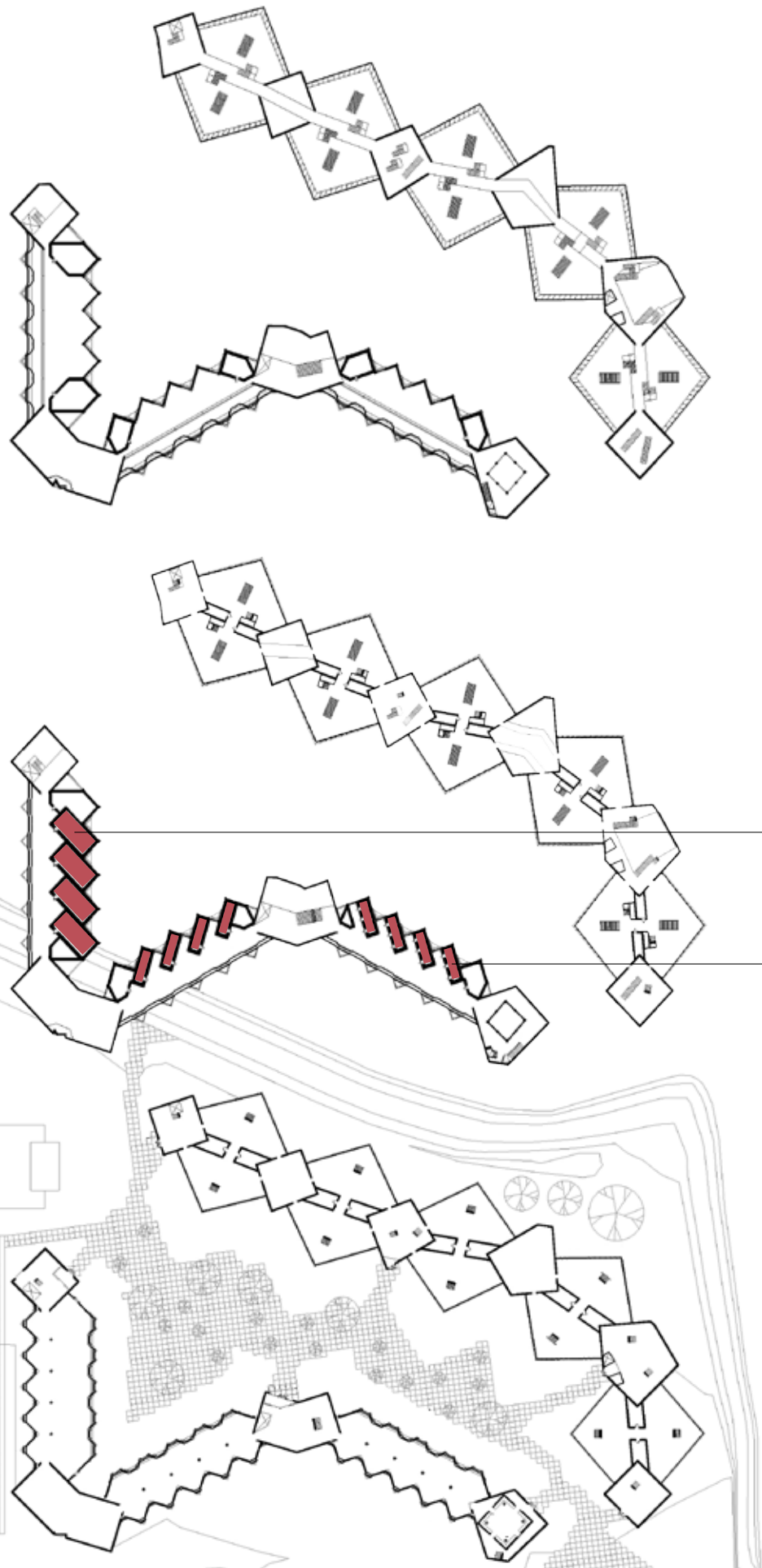

RESEARCH WORKSPACES

16 team workspaces

1 library

LABORATORIES

12 headphone booths

4 EEG booths

1 MEG suite

1 fMRI suite

1 synthetic sound field room

1 anechoic chamber

ADMINISTRATION

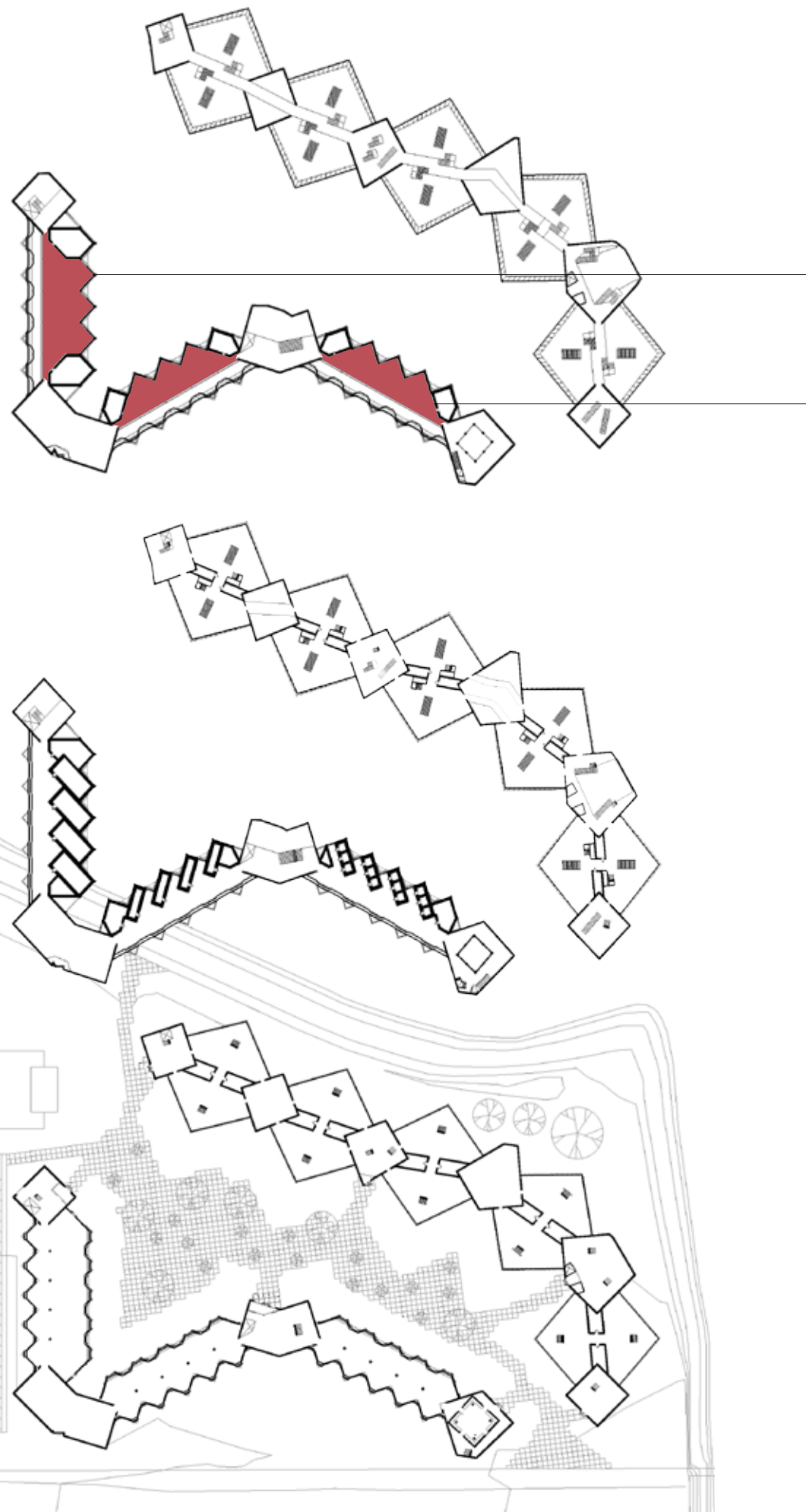

RESEARCH WORKSPACES

16 team workspaces

1 library

LABORATORIES

12 headphone booths

4 EEG booths

1 MEG suite

1 fMRI suite

1 synthetic sound field room

1 anechoic chamber

ADMINISTRATION

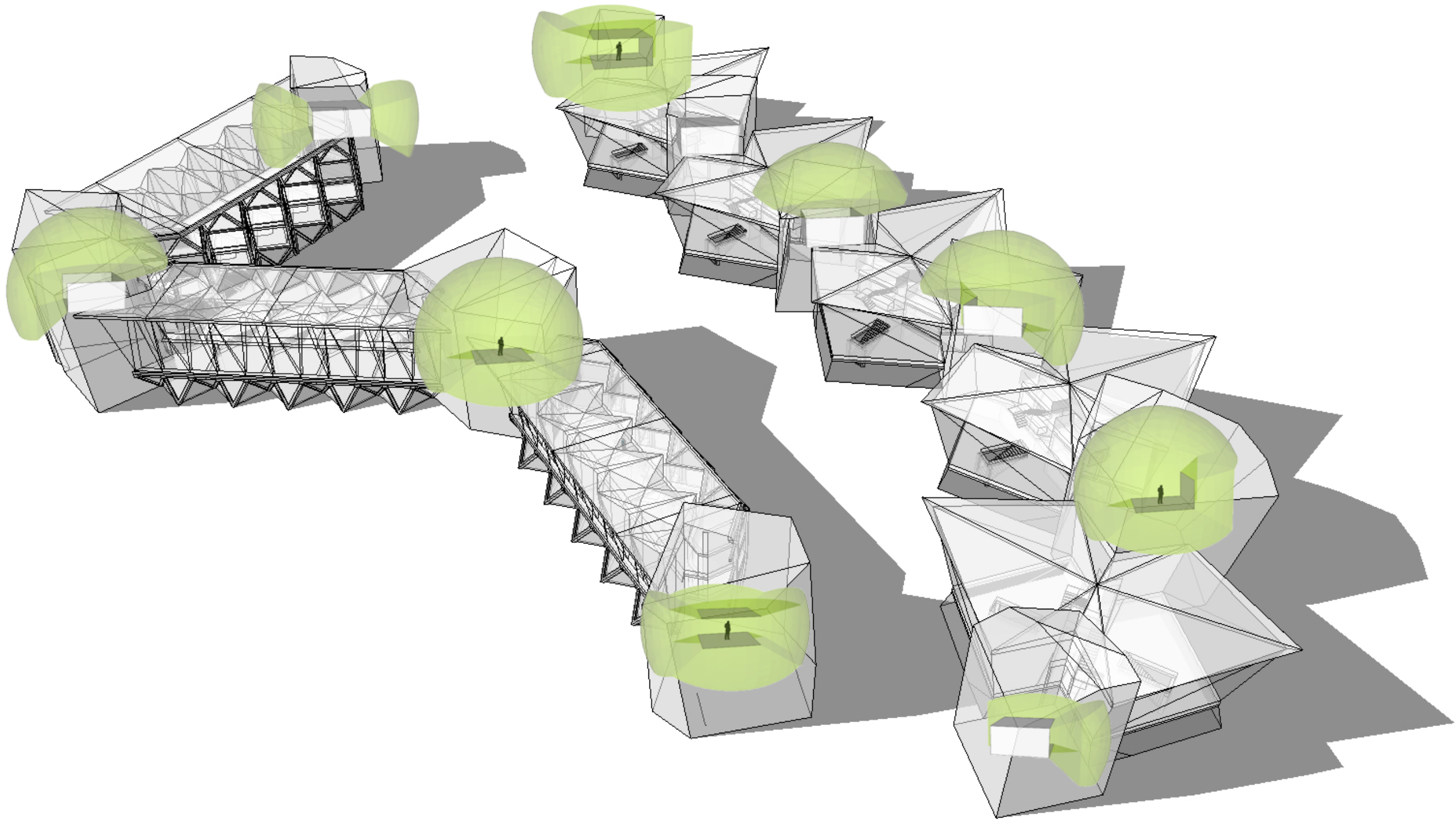

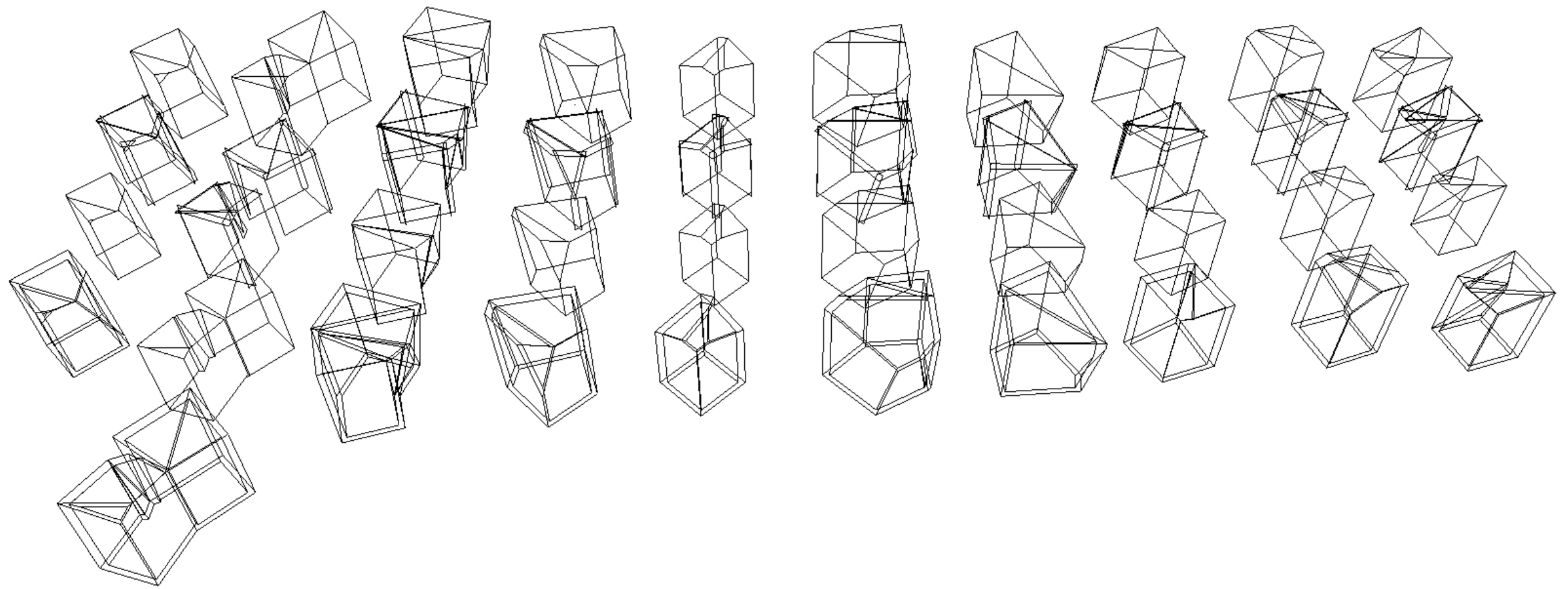
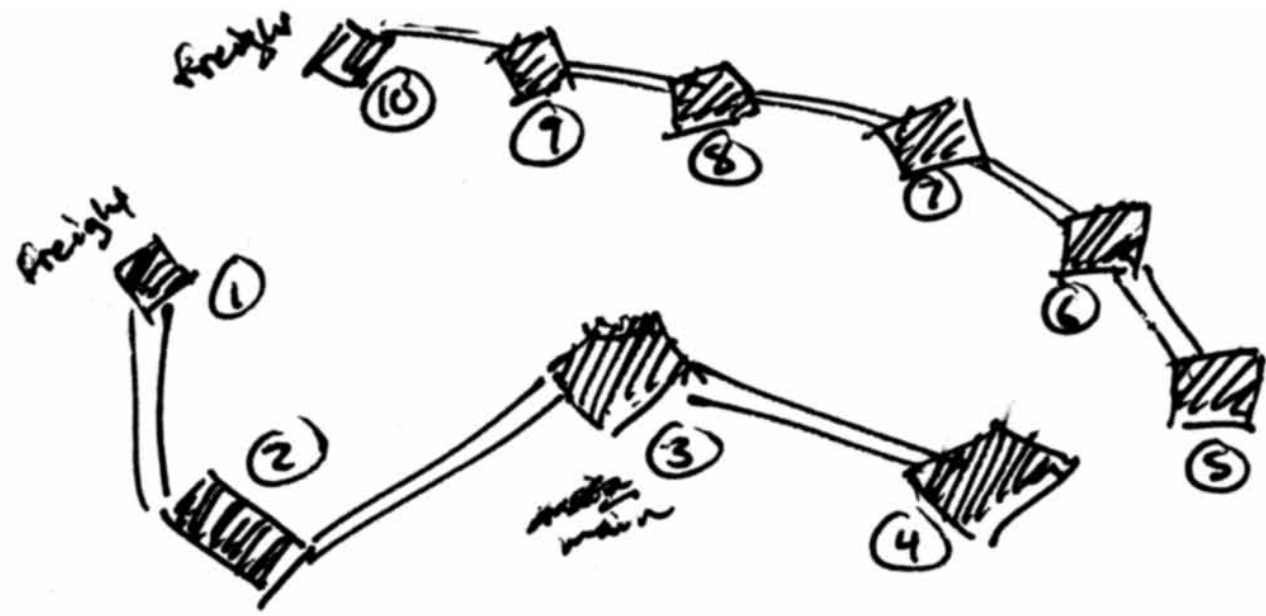



thick forest



cave
cathedral
beach
machine
music
tunnel

wind
railway station
landmark, ancient
singing road
birds
whistling

way of silence
outdoors
wind chimes
babble
bell
footsteps
silence
canyon



filtered



powerful



tall proportion
as open as possible
reverberant
stone - reflective



open field
beach
sand of steps



reflective
constricted



echoes
chambers
concealed



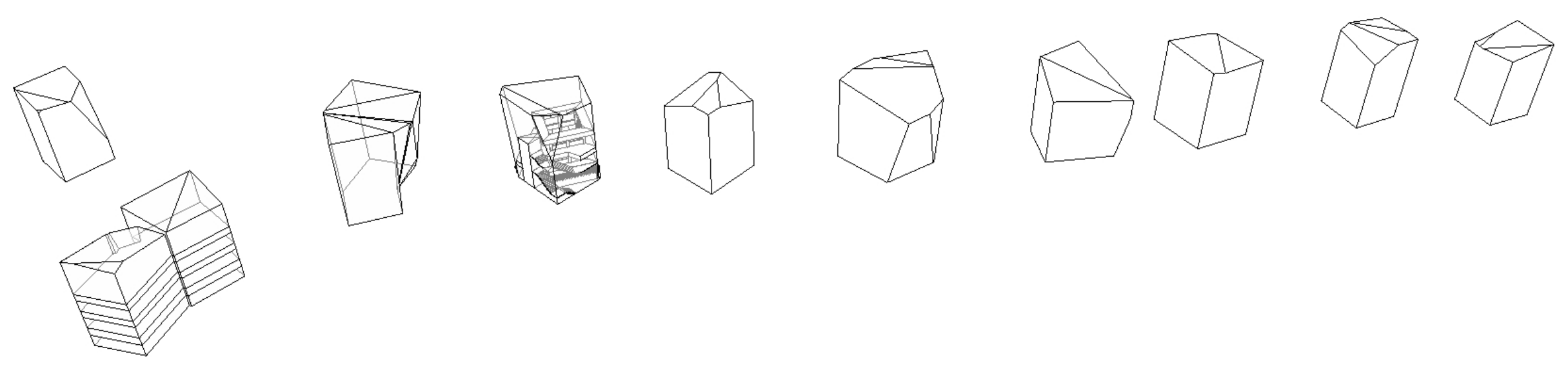
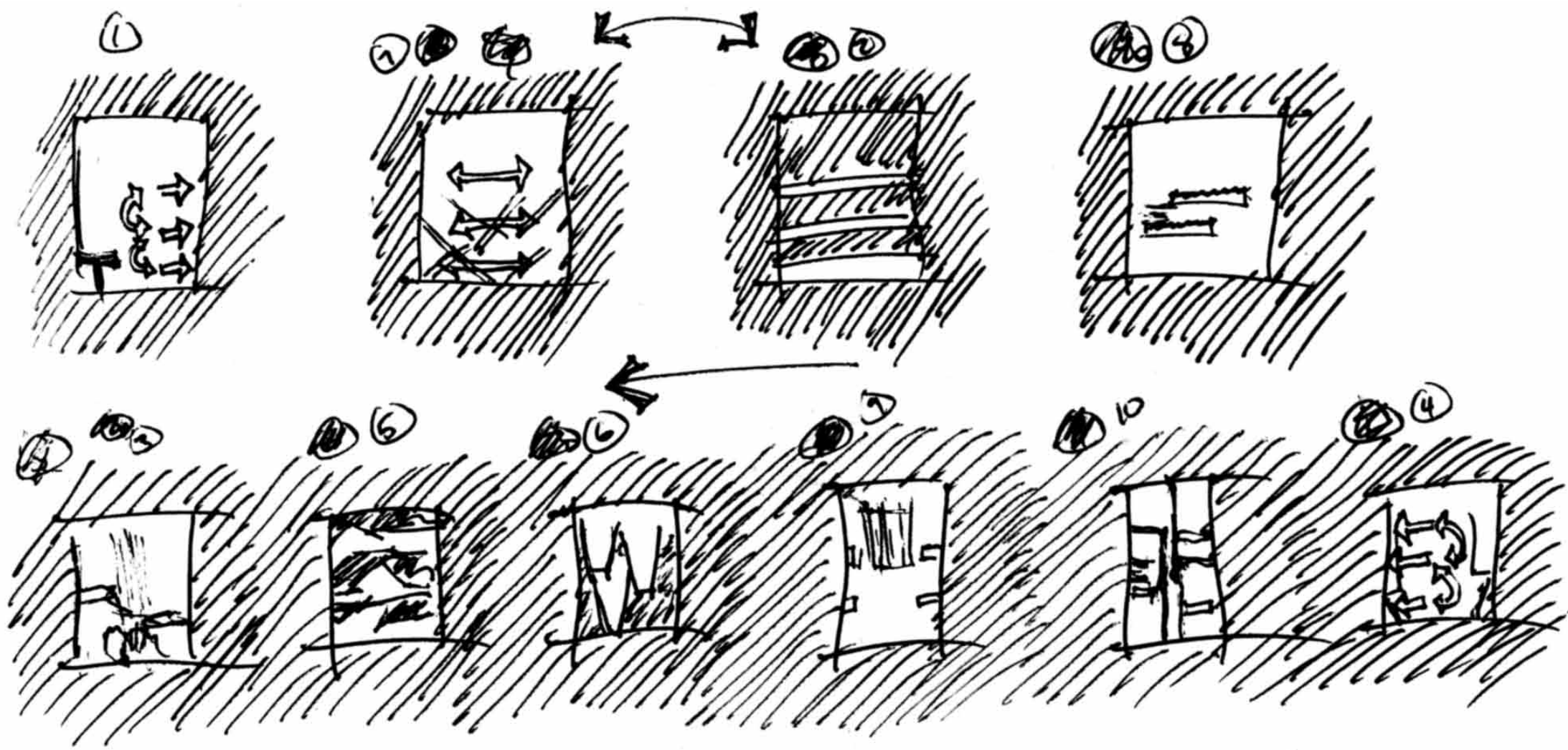

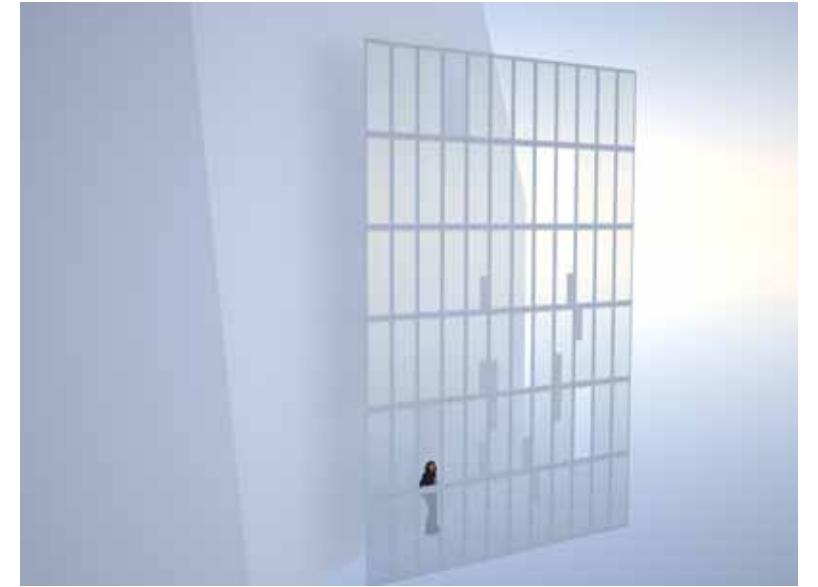
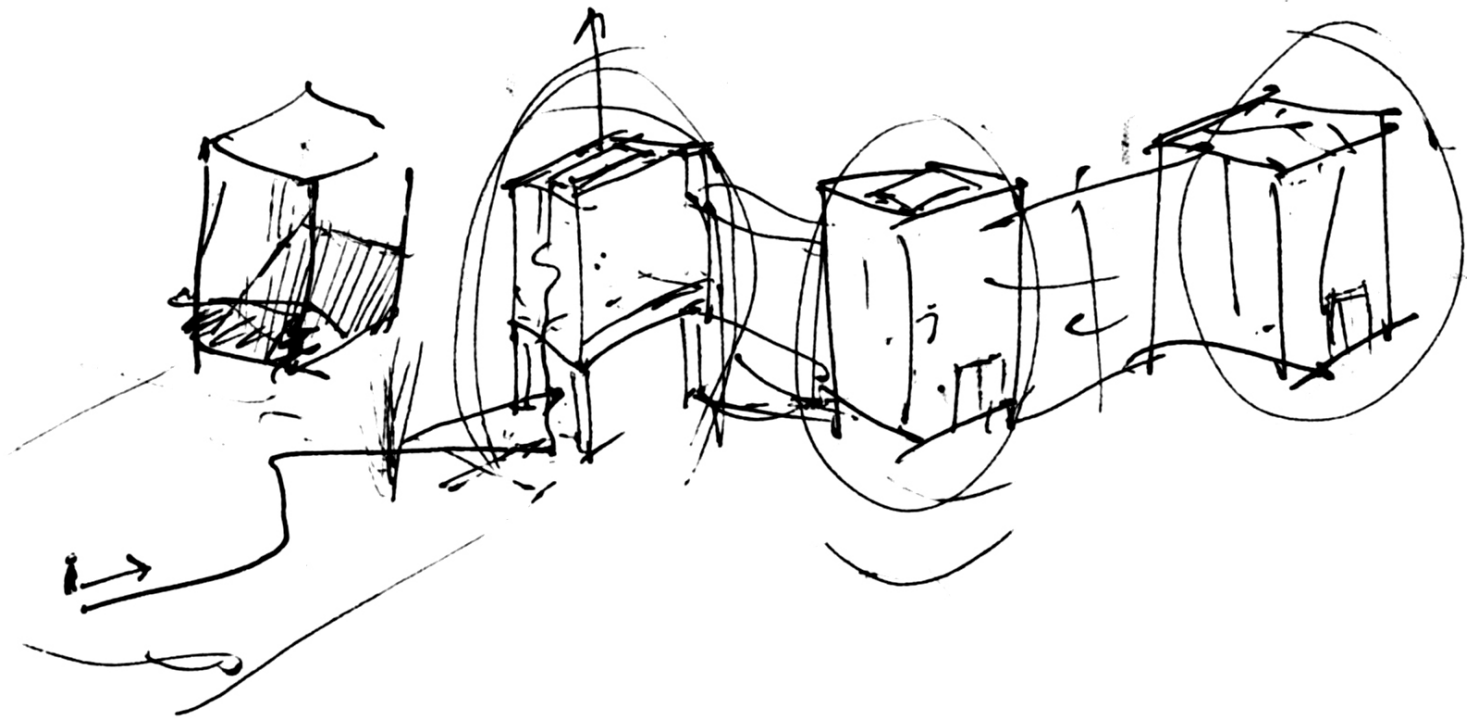

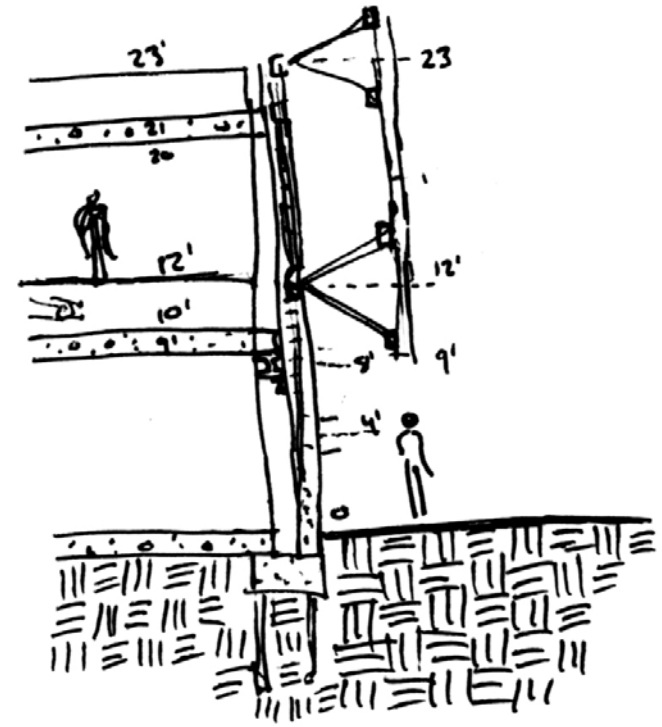
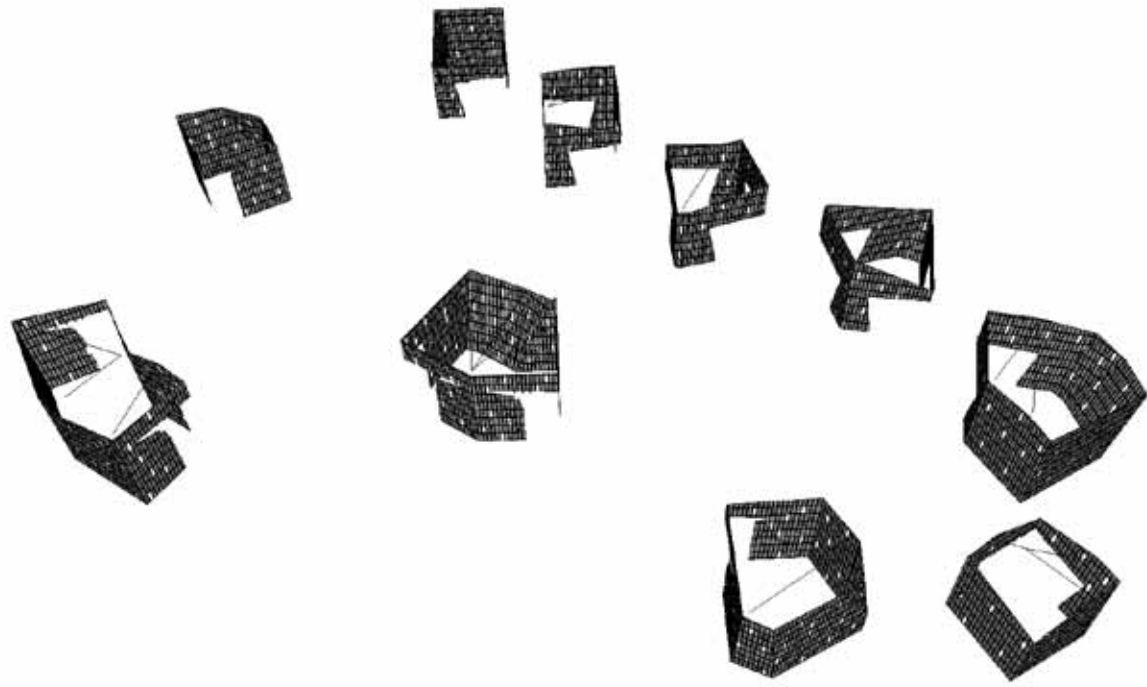

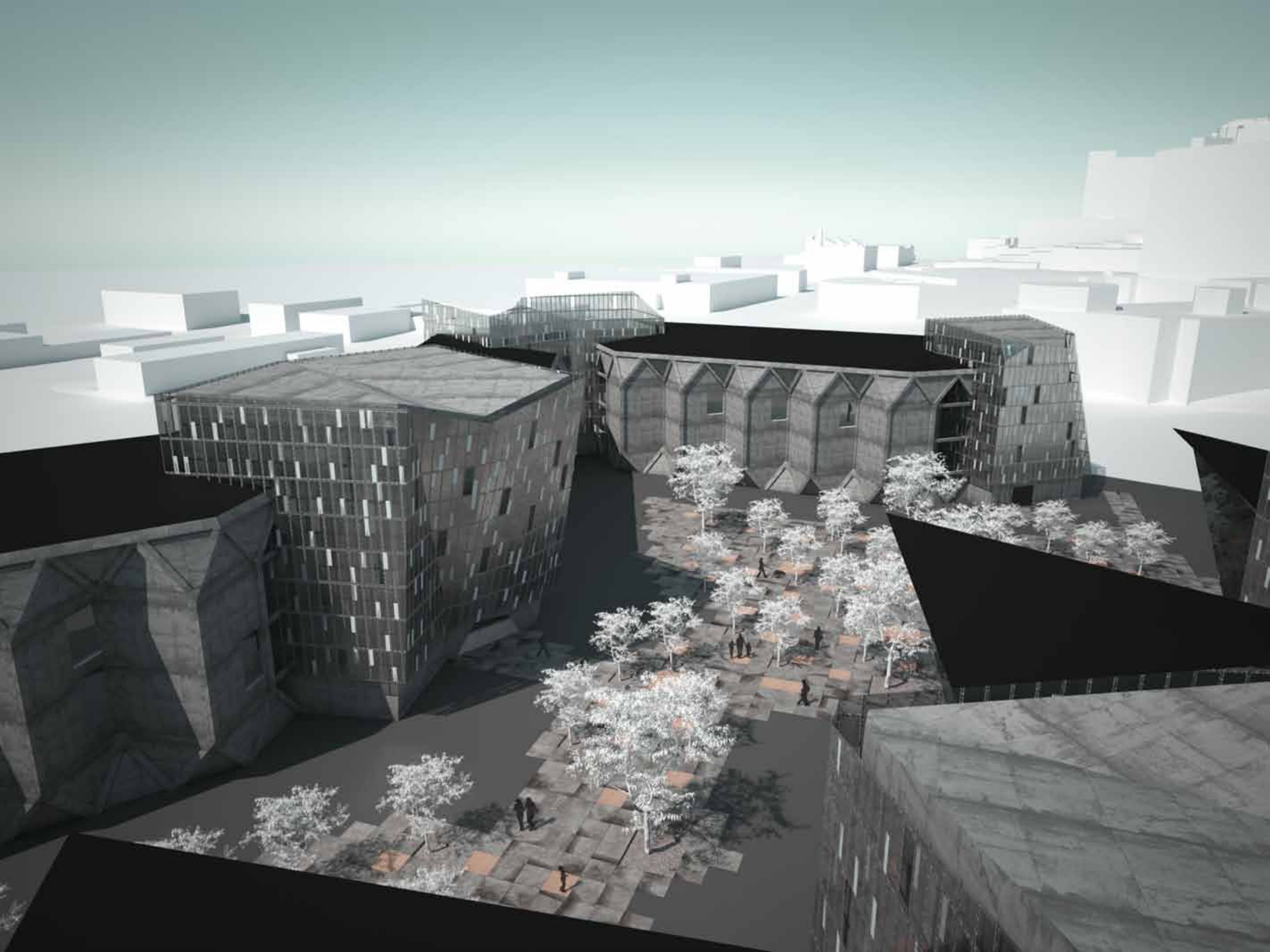

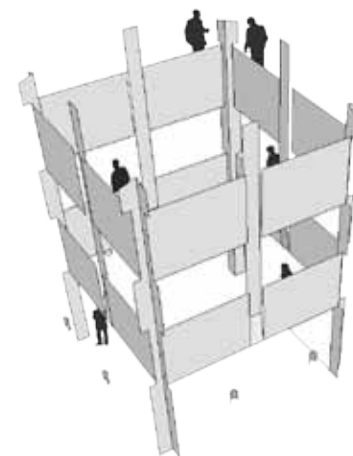
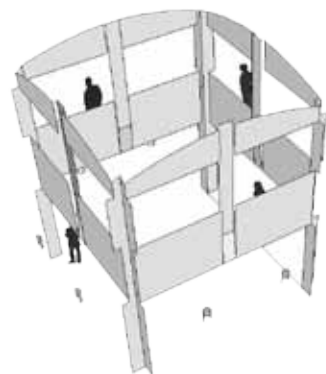
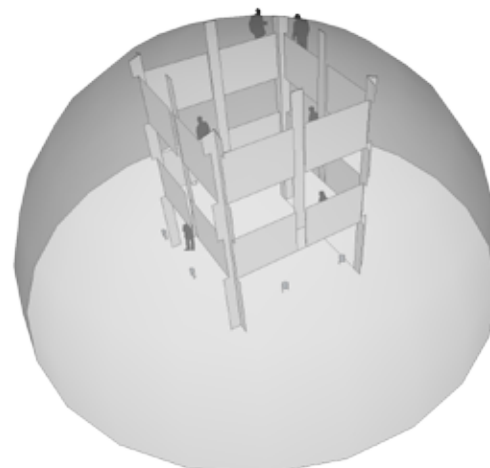
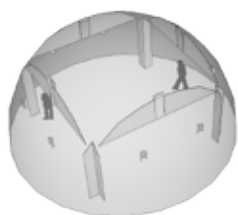
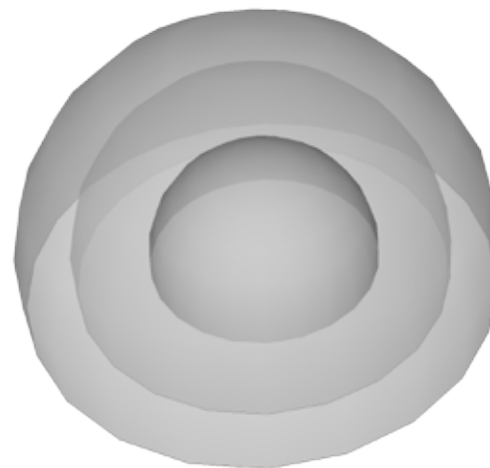
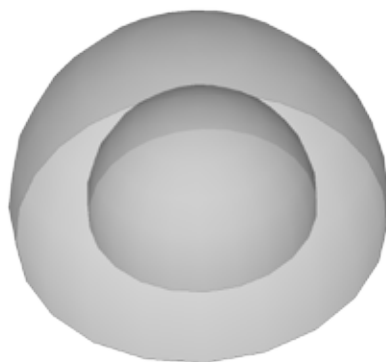
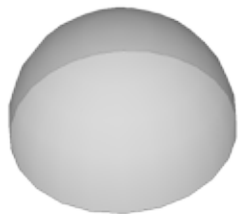

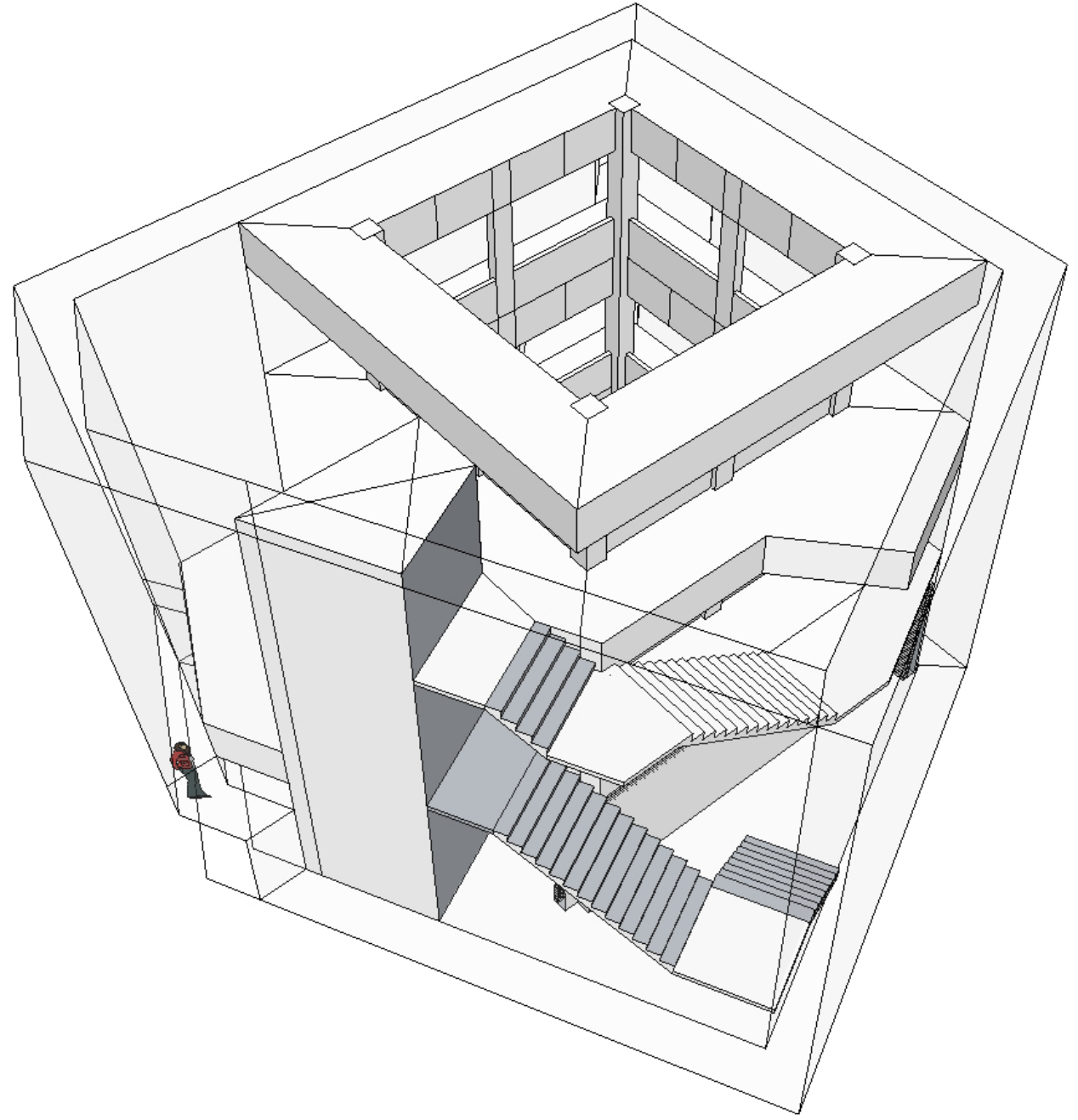
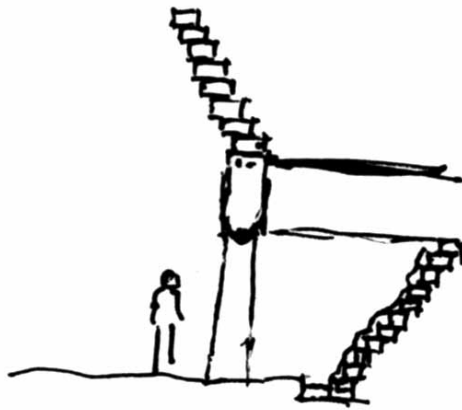



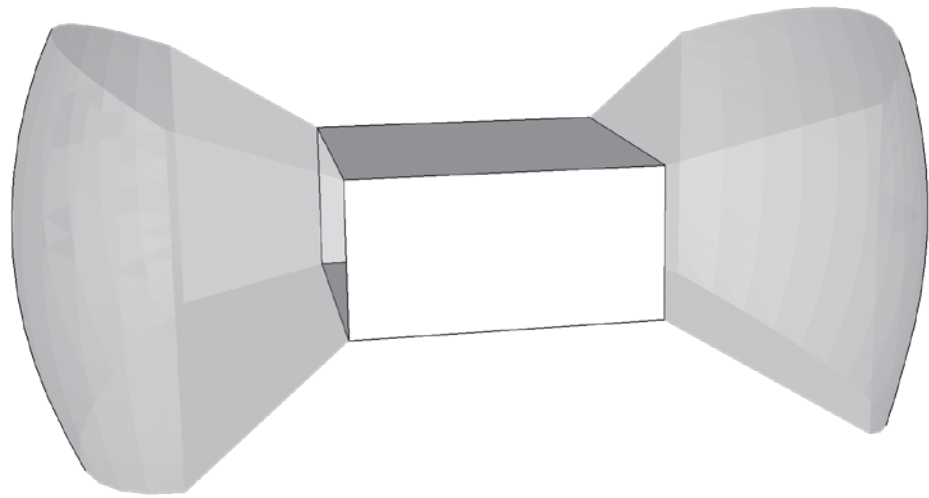
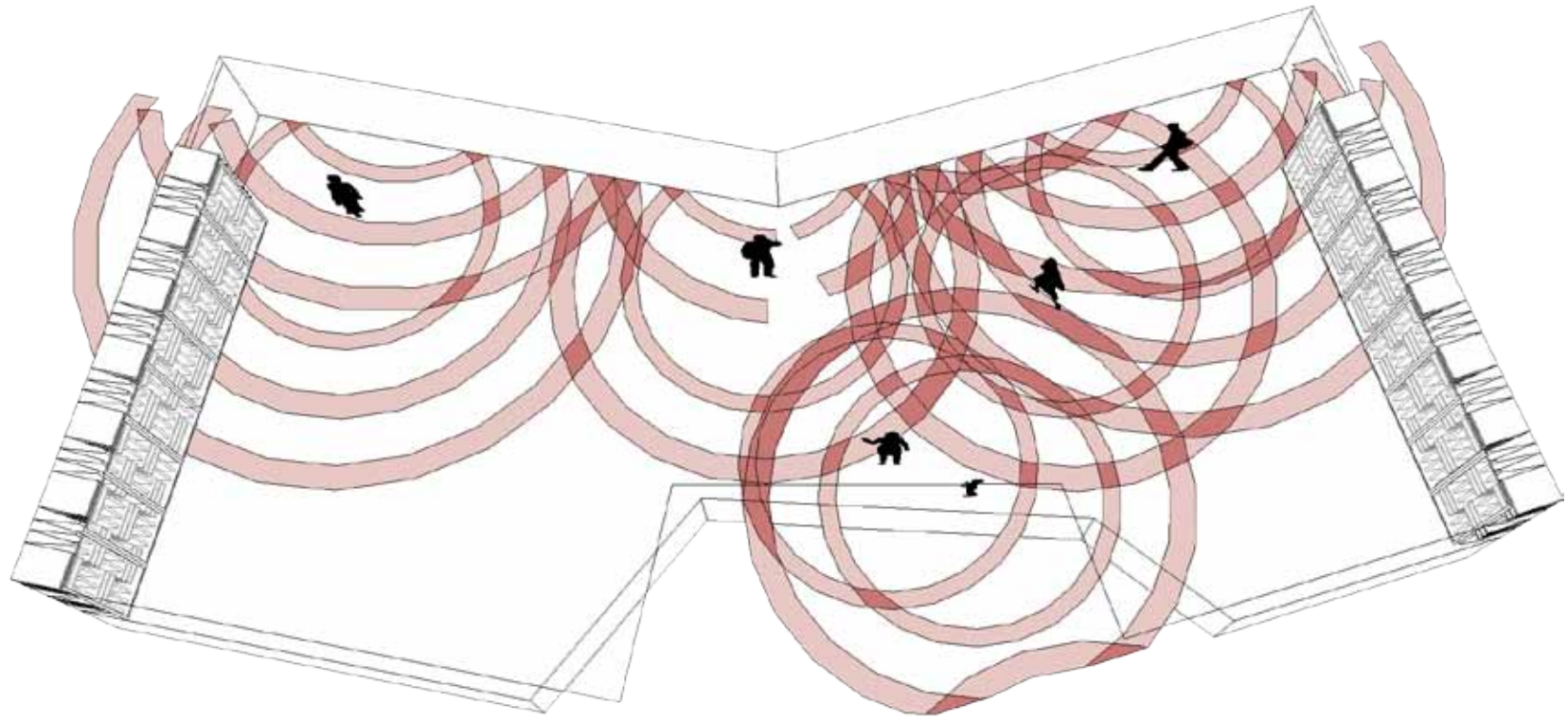



How can architecture improve the standing of sound in the designed environment?



QUESTIONS?

